

**5.2 - CAJAS PARA AREAS PELIGROSAS. SERIE GR. LIBRE DE COBRE
CON RECUBRIMIENTO EXTERIOR DE PVC E INTERIOR DE URETANO PURPURA.**
**5.2 - HAZARDOUS LOCATION CONDUIT OUTLET BOXES. GR SERIES. COPPER FREE
ALUMINUM. WITH PVC COATING AND PURPLE URETHANE INNER COATING.**

Hoja: 1 / 3
Page:

FICHA TECNICA / TECHNICAL DATA

007 - RW - 125

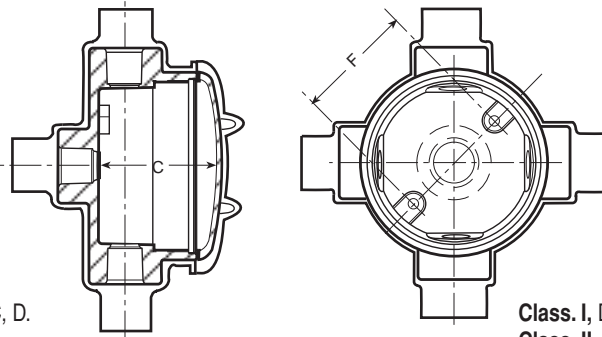

Para dimensiones:
Ver Ficha Tecnica 007 - RW - 202

For dimensions:
See Technical Data 007-RW-202.

Clase I, Div. 1 & 2, grupos B ϕ , C, D.

Clase II, Div. 1, grupos E, F, G.

Clase II, Div. 2, grupos F, G.

Clase III.

NEMA 3, 4 X, 7 CD, 9 EFG.

A prueba de explosión.

A prueba de polvos inflamables.

A prueba de agua.

A prueba de ambientes humedos.

- Recubrimiento PVC: 40 mil. mínimo.
- Uretano PURPURA: 2 mil. mínimo.
- Mangas en las entradas para un sellado hermético.
- Material del cuerpo y tapa: Aluminio libre de cobre inyectado a presión (diecast).
- " O " ring de Neopreno a prueba de humedad.
- Tornillo de tierra pasivado incluido.
- Rosca NPT para usarse con tubo conduit RIGIDO.
- Fabricación en base a: UL 886

CAN/CSA - C22.2 No. 30

Class. I, Div. 1 & 2, Groups B ϕ , C, D

Class. II, Div. 1, Groups E, F, G

Class. II, Div. 2, Groups F, G

Class. III.

NEMA 3, 4, 7 CD, 9 EFG

Explosionproof

Dust - Ignitionproof

Raintight

Wet Locations

- PVC coating: 40 mil. min.
- PURPLE Urethane: 2 mil. min.
- Pressure sealing sleeves on conduit openings.
- Diecast copper free aluminum.
- " O " ring Neoprene provide raintight fit.
- Green ground screw included.
- NPT threaded for use with RIGID conduit.
- Manufactured in compliance with: UL 886

CAN/CSA - C22.2 No. 30

USAR No. DE CODIGO PARA HACER PEDIDOS / TO ORDER USE CODE NUMBER

Figura Figure	Modelo Model	Salidas Hubs	Catalogo Catalog	Codigo Code	Medida nominal Hub size		Abertura Cover opening diameter		Volumen Volume		Peso x 100 Weight x 100		Pqt. Unit. Pzas.	Std. Pkg. Pzas.
					mm.	inch	mm.	inch	cm. ³	cu. in	Kg	Lb		
	GRE	1	GRE-0447-PC	04.08.2053.PC	12.7	1/2	83	3.27	246.0	15.0	57	124		24
			GRE-0448-PC	04.08.2054.PC	19.0	3/4	83	3.27	246.0	15.0	55	120		24
			GRE-0582-PC	04.08.2429.PC	25.4	1	83	3.27	300.0	18.31	69.5			17
			GRE-0587-PC	04.08.2430.PC	31.8	1 1/4	127	5.0	1259	76.8				4
			GRE-0598-PC	04.08.2431.PC	38.1	1 1/2	127	5.0	1259	76.8				4
			GRE-0603-PC	04.08.2432.PC	50.8	2	127	5.0	1389	84.8				4
	GRC	2	GRC-0443-PC	04.08.2049.PC	12.7	1/2	83	3.27	246.0	15.0	59	129		18
			GRC-0444-PC	04.08.2050.PC	19.0	3/4	83	3.27	246.0	15.0	57	124		18
			GRC-0556-PC	04.08.2433.PC	25.4	1	83	3.27	300.0	18.31	72	159		14
			GRC-0589-PC	04.08.2434.PC	31.8	1 1/4	127	5.0	1259	76.8	129	284		4
			GRC-0561-PC	04.08.2435.PC	38.1	1 1/2	127	5.0	1259	76.8	133	293		3
			GRC-0580-PC	04.08.2436.PC	50.8	2	127	5.0	1389	84.8	221	486		3

Especificaciones sujetas a cambio sin previo aviso. Specifications are subject to change without notice.

① Group B authorized only by
① Grupo B autorizado solo por

RAWELT, S.A. de C.V.

RAWELT
PURPURA COAT

22 - V - 2009





**5.2 - CAJAS PARA AREAS PELIGROSAS. SERIE GR. LIBRE DE COBRE
CON RECUBRIMIENTO EXTERIOR DE PVC E INTERIOR DE URETANO PURPURA.
5.2 - HAZARDOUS LOCATION CONDUIT OUTLET BOXES. GR SERIES. COPPER FREE
ALUMINUM. WITH PVC COATING AND PURPLE URETHANE INNER COATING.**

Hoja: 2 / 3
Page:

FICHA TECNICA / TECHNICAL DATA

007 - RW - 125

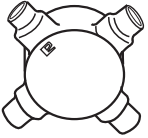
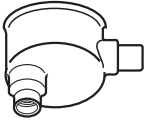
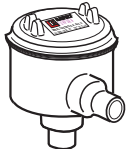
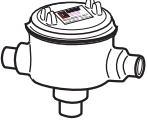
USAR No. DE CODIGO PARA HACER PEDIDOS / TO ORDER USE CODE NUMBER

Figura Figure	Modelo Model	Salidas Hubs	Catalogo Catalog	Codigo Code	Medida nominal Hub size		Abertura Cover opening diameter		Volumen Volume		Peso x 100 Weight x 100		Pqt. Unit. Pzas. Pcs.	Std. Pkg. Pzas. Pcs.		
					mm	inch.	mm	inch.	cm ³	cu. in	kg	Lb				
	GRL	2	GRL-0439-PC	04.08.2045.PC	12.7	1/2	83	3.27	246.0	15.0	57	124		20		
			GRL-0440-PC	04.08.2046.PC	19.0	3/4	83	3.27	246.0	15.0	61	134		20		
			GRL-0546-PC	04.08.2437.PC	25.4	1	83	3.27	300.0	18.31	68	150		14		
			GRL-0591-PC	04.08.2438.PC	31.8	1 1/4	127	5.0	1259	76.8	227	500		4		
			GRL-0558-PC	04.08.2439.PC	38.1	1 1/2	127	5.0	1259	76.8	219	482		4		
			GRL-0576-PC	04.08.2440.PC	50.8	2	127	5.0	1389	84.8	229	504		4		
	GRT	3	GRT-0441-PC	04.08.2047.PC	12.7	1/2	83	3.27	246.0	15.0	62	136		16		
			GRT-0442-PC	04.08.2048.PC	19.0	3/4	83	3.27	246.0	15.0	61	133		16		
			GRT-0547-PC	04.08.2441.PC	25.4	1	83	3.27	300.0	18.31	74	164		12		
			GRT-0593-PC	04.08.2442.PC	31.8	1 1/4	127	5.0	1259	76.8	237	523		3		
			GRT-0559-PC	04.08.2443.PC	38.1	1 1/2	127	5.0	1259	76.8	198	435		3		
			GRT-0578-PC	04.08.2444.PC	50.8	2	127	5.0	1389	84.8	221	486		3		
	GRX	4	GRX-0449-PC	04.08.2055.PC	12.7	1/2	83	3.27	246.0	15.0				16		
			GRX-0450-PC	04.08.2056.PC	19.0	3/4	83	3.27	246.0	15.0				60	131	16
			GRX-0585-PC	04.08.2445.PC	25.4	1	83	3.27	300.0	18.31				75	165	10
			GRX-0595-PC	04.08.2446.PC	31.8	1 1/4	127	5.0	1259	76.8				241	531	3
			GRX-0601-PC	04.08.2447.PC	38.1	1 1/2	127	5.0	1259	76.8						3
			GRX-0606-PC	04.08.2448.PC	50.8	2	127	5.0	1389	84.8				230	506	3
	GRB	2	GRB-0445-PC	04.08.2051.PC	12.7	1/2	83	3.27	246.0	15.0				17		
			GRB-0446-PC	04.08.2052.PC	19.0	3/4	83	3.27	246.0	15.0				65	143	17
			GRB-0584-PC	04.08.2449.PC	25.4	1	83	3.27	300.0	18.31				70	153	14
			GRB-0597-PC	04.08.2450.PC	31.8	1 1/4	127	5.0	1259	76.8				124	273	4
			GRB-0600-PC	04.08.2451.PC	38.1	1 1/2	127	5.0	1259	76.8				214	471	4
			GRB-0605-PC	04.08.2452.PC	50.8	2	127	5.0	1389	84.8				230	506	4
	GREZ	2	GREZ-0466-PC	04.08.2063.PC	12.7	1/2	83	3.27	246.0	15.0				12		
			GREZ-0467-PC	04.08.2064.PC	19.0	3/4	83	3.27	246.0	15.0				55	120	12
			GREZ-0583-PC	04.08.2453.PC	25.4	1	83	3.27	300.0	18.31				70	153	
			GREZ-0588-PC	04.08.2454.PC	31.8	1 1/4	127	5.0	1259	76.8						
			GREZ-0599-PC	04.08.2455.PC	38.1	1 1/2	127	5.0	1259	76.8						
			GREZ-0604-PC	04.08.2456.PC	50.8	2	127	5.0	1389	84.8						
	GRCZ	3	GRCZ-0464-PC	04.08.2061.PC	12.7	1/2	83	3.27	246.0	15.0				10		
			GRCZ-0465-PC	04.08.2062.PC	19.0	3/4	83	3.27	246.0	15.0				60	131	10
			GRCZ-0557-PC	04.08.2457.PC	25.4	1	83	3.27	300.0	18.31						
			GRCZ-0590-PC	04.08.2458.PC	31.8	1 1/4	127	5.0	1259	76.8						
			GRCZ-0562-PC	04.08.2459.PC	38.1	1 1/2	127	5.0	1259	76.8				198	435	
			GRCZ-0581-PC	04.08.2460.PC	50.8	2	127	5.0	1389	84.8						
	GRLZ	3	GRLZ-0460-PC	04.08.2057.PC	12.7	1/2	83	3.27	246.0	15.0				10		
			GRLZ-0461-PC	04.08.2058.PC	19.0	3/4	83	3.27	246.0	15.0				60	131	10
			GRLZ-0573-PC	04.08.2461.PC	25.4	1	83	3.27	300.0	18.31						
			GRLZ-0592-PC	04.08.2462.PC	31.8	1 1/4	127	5.0	1259	76.8						
			GRLZ-0574-PC	04.08.2463.PC	38.1	1 1/2	127	5.0	1259	76.8						
			GRLZ-0577-PC	04.08.2464.PC	50.8	2	127	5.0	1389	84.8						

Especificaciones sujetas a cambio sin previo aviso. Specifications are subject to change without notice..

RAWELT, S.A. de C.V.



22 - V - 2009



5.2 - CAJAS PARA AREAS PELIGROSAS. SERIE GR. LIBRE DE COBRE
CON RECUBRIMIENTO EXTERIOR DE PVC E INTERIOR DE URETANO PURPURA.
HAZARDOUS LOCATIONS CONDUIT OUTLET BOXES. GR SERIES. COPPER FREE
ALUMINUM. WITH PVC EXTERIOR COATING AND PURPLE URETHANE ON THE INSIDE.

Hoja: 3 / 3
 Page:

FICHA TECNICA / TECHNICAL DATA

007 - RW - 125

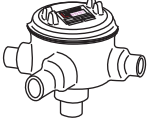
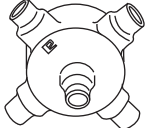
USAR No. DE CODIGO PARA HACER PEDIDOS / TO ORDER USE CODE NUMBER

Figura Figure	Modelo Model	Salidas Hubs	Catalogo Catalog	Codigo Code	Medida nominal Hub size		Abertura Cover opening diameter		Volumen Volume		Peso x 100 Weight x 100		Pqt. Unit. Pzas. Pcs.	Std. Pkg. Pcs.
					mm	inch.	mm	inch.	cm ³	cu. in	kg	Lb		
	GRTZ	4	GRTZ-0462-PC	04.08.2059.PC	12.7	1/2	83	3.27	246.0	15.0	64	141	8	
			GRTZ-0463-PC	04.08.2060.PC	19.0	3/4	83	3.27	246.0	15.0	8			
			GRTZ-0555-PC	04.08.2465.PC	25.4	1	83	3.27	300.0	18.31				
			GRTZ-0594-PC	04.08.2466.PC	31.8	1 1/4	127	5.0	1259	76.8				
			GRTZ-0560-PC	04.08.2467.PC	38.1	1 1/2	127	5.0	1259	76.8				
			GRTZ-0579-PC	04.08.2468.PC	50.8	2	127	5.0	1389	84.8				
	GRXZ	5	GRXZ-0468-PC	04.08.2065.PC	12.7	1/2	83	3.27	246.0	15.0			8	
			GRXZ-0469-PC	04.08.2066.PC	19.0	3/4	83	3.27	246.0	15.0	8			
			GRXZ-0586-PC	04.08.2469.PC	25.4	1	83	3.27	300.0	18.31				
			GRXZ-0596-PC	04.08.2470.PC	31.8	1 1/4	127	5.0	1259	76.8				
			GRXZ-0602-PC	04.08.2471.PC	38.1	1 1/2	127	5.0	1259	76.8				
			GRXZ-0607-PC	04.08.2472.PC	50.8	2	127	5.0	1389	84.8				
	EA-0545 EA-2325	04.05.0545 04.05.2325	Diametro interior Inside diameter		Sección Section									
			mm	inch.	mm	inch.								
			75.87	2.987	2.62	0.103								
			129.77	5.109	3.53	0.139								
			Descripción / Description											
	GR-0451.PC	04.17.3242.PC	Tapa GR 12.7 a 25.4 (1/2 a 1). M 85 x 2										81	
	GR-3231.PC	04.17.3244.PC	Tapa GR 12.7 a 25.4 (1/2 a 1). M 84.5 x 1.5										81	
	GR-0575.PC	04.17.3243.PC	Tapa GR 31.8 a 50.8 (1 1/4 a 2). M 136.7 x 2.5										32	
GR-3232.PC	04.17.3245.PC	Tapa GR 31.8 a 50.8 (1 1/4 a 2). M 136 x 1.75										32		

Certificaciones / Compliances:



Expediente/File No. LR 105795-2
 Expediente/File No. LR 105795-7



Expediente/File No. E181329

Especificaciones sujetas a cambio sin previo aviso. Specifications are subject to change without notice.

RAWELT, S.A. de C.V.



22 - V - 2009