

**3.3 - CAJA RECTANGULAR. A PRUEBA DE INTEMPERIE. SERIE RR.
CON RECUBRIMIENTO EXTERIOR DE PVC E INTERIOR DE URETANO PURPURA.**

**3.3 - WEATHERPROOF SINGLE GANG BOX. RR SERIES.
WITH PVC COATING AND PURPLE URETHANE INNER COATING.**

Hoja: 1 / 4
Page:

FICHA TECNICA / TECHNICAL DATA

007 - RW - 197

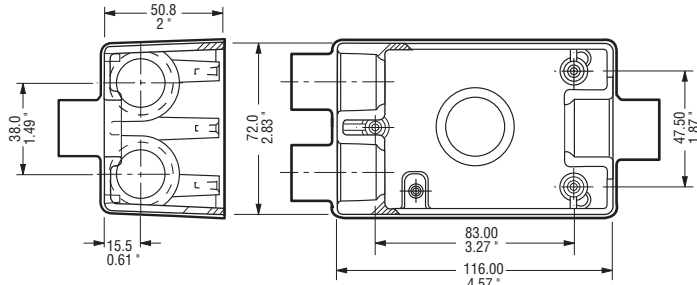

Dimensiones en pulgadas y milímetros.
Dimensions in inches and millimeters.



- A prueba de áreas corrosivas.
- Recubrimiento PVC: 40 mil. mínimo.
- Uretano PURPURA: 2 mil. mínimo.
- Mangas en las entradas para un sellado hermético.
- Material: Aluminio inyectado a presión (diecast).
- Rosca NPT para usarse con tubo conduit RIGIDO e IMC.
- Tornillo de tierra pasivado incluido.
- A prueba de intemperie.

APLICACIONES:

- Pueden ser instaladas para recibir accesorios como: Interruptores, contactos, estaciones de botones, luces piloto.
- Sirven para hacer empalmes y conexiones en el cableado. Permite fácil acceso para mantenimiento.
- Fabricación en base a: UL 514 A, UL 514 B
CAN/CSA-C22.2 No. 18-92

- For use in corrosive atmospheres.
- PVC Coating: 40 mil. min.
- PURPLE Urethane: 2 mil. min.
- Pressure sealing sleeves on conduit openings.
- Material: Diecast aluminum.
- NPT threaded for use with RIGID and IMC conduit.
- Green ground screw included.
- For wet locations.

APPLICATIONS:

- They can be installed to accommodate accessories such as switches, receptacles.
- Provide openings for making splice and taps. Allow access for maintenance.
- Manufactured in compliance with: UL 514 A, UL 514 B
CAN/CSA-C22.2 No. 18-92

USAR No. DE CODIGO PARA HACER PEDIDOS / TO ORDER USE CODE NUMBER

Figura Figure	Bocas Hubs	Catálogo Catalog	Código Code	Medida nominal Hub size		Volumen Volume		Peso x 100 pzas. Weight x 100 pcs.				Std Pkg. Pzas. Pcs.
				mm	inch	cm ³	cu. in	kg	Lb			
	Arriba/Top 1	RR-0505-PC	01.07.2802.PC	12.7	1/2	308.3	18.8	33.4	73.4			30
		RR-0506-PC	01.07.2803.PC	19.0	3/4	308.3	18.8	34.3	75.4			30
		RR-2631-PC	01.07.2806.PC	25.4	1	246.0	15.0	41.6	91.5			30
	Arriba/Top 1	RR-0470-PC	01.07.2790.PC	12.7	1/2	300.1	18.3	35.1	77.2			30
	Abajo/Bottom 1	RR-0471-PC	01.07.2791.PC	19.0	3/4	295.2	18.0	36.1	79.5			24
		RR-2742-PC	01.07.2807.PC	25.4	1	246.0	15.0	43.3	95.3			24
	Arriba/Top 1	RR-0472-PC	01.07.2792.PC	12.7	1/2	275.5	16.8	45.4	99.9			30
	Abajo/Bottom 2	RR-0473-PC	01.07.2793.PC	19.0	3/4	275.5	16.8	46.1	101.6			24
	Arriba/Top 1	RR-0480-PC	01.07.2800.PC	12.7	1/2	275.5	16.8	45.4	99.9			26
	Abajo/Bottom 1	RR-0481-PC	01.07.2801.PC	19.0	3/4	275.5	16.8	46.1	101.6			20
	Izquierda/Left 1	RR-2743-PC	01.07.2808.PC	25.4	1	234.5	14.3	53.2	117.0			20
	Arriba/Top 1	RR-0474-PC	01.07.2794.PC	12.7	1/2	275.5	16.8	47.6	104.7			20
	Abajo/Bottom 1	RR-0475-PC	01.07.2795.PC	19.0	3/4	275.5	16.8	48.8	107.3			16
	Izquierda/Left 1	RR-2744-PC	01.07.2809.PC	25.4	1	234.5	14.3	55.4	121.8			16

Especificaciones sujetas a cambio sin previo aviso. Specifications are subject to change without notice.

RAWELT, S.A. de C.V.

RAWELT INYECTADOS

Una División del Grupo REVUELTA

22 - V - 2009

**3.3 - CAJA RECTANGULAR. A PRUEBA DE INTEMPERIE. SERIE RR.
CON RECUBRIMIENTO EXTERIOR DE PVC E INTERIOR DE URETANO PURPURA.**

**3.3 - WEATHERPROOF SINGLE GANG BOX. RR SERIES.
WITH PVC COATING AND PURPLE URETHANE INNER COATING.**

Hoja: 2 / 4
Page:

FICHA TECNICA / TECHNICAL DATA

007 - RW - 197

USAR No. DE CODIGO PARA HACER PEDIDOS / TO ORDER USE CODE NUMBER

Figura Figure	Bocas Hubs	Catálogo Catalog	Código Code	Medida nominal Hub size		Volumen Volume		Peso x 100 pzas. Weight x 100 pcs.		Std Pkg. Pzas. Pcs.	
				mm	inch	cm ³	cu. in	kg	Lb		
	Arriba/Top	2	RR-0476-PC	01.07.2796.PC	12.7	1/2	267.3	16.3	47.6	104.7	30
	Abajo/Bottom	2	RR-0477-PC	01.07.2797.PC	19.0	3/4	267.3	16.3	48.8	107.3	24
	Arriba/Top	1	RR-0478-PC	01.07.2798.PC	12.7	1/2	267.3	16.3	50.2	110.4	20
	Abajo/Bottom	1	RR-0479-PC	01.07.2799.PC	19.0	3/4	267.3	16.3	51.7	113.7	16
	Izquierda/Left	2									
	Derecha/Right	1									
	Arriba/Top	1	RR-0507-PC	01.07.2804.PC	12.7	1/2	308.3	18.8			
	Detrás/Back	1	RR-0508-PC	01.07.2805.PC	19.0	3/4	303.4	18.5			
			RR-2745-PC	01.07.2810.PC	25.4	1	246.0	15.0			
	Arriba/Top	1	RR-0281-PC	01.07.2778.PC	12.7	1/2	300.1	18.3			
	Abajo/Bottom	1	RR-0282-PC	01.07.2779.PC	19.0	3/4	295.2	18.0			
	Detrás/Back	1	RR-2746-PC	01.07.2811.PC	25.4	1	246.0	15.0			
	Arriba/Top	1	RR-0283-PC	01.07.2780.PC	12.7	1/2	275.5	16.8			
	Abajo/Bottom	2	RR-0284-PC	01.07.2781.PC	19.0	3/4	275.5	16.8			
	Detrás/Back	1									
	Arriba/Top	1	RR-0454-PC	01.07.2788.PC	12.7	1/2	275.5	16.8			
	Abajo/Bottom	1	RR-0455-PC	01.07.2789.PC	19.0	3/4	275.5	16.8			
	Izquierda/Left	1	RR-2747-PC	01.07.2812.PC	25.4	1	234.5	14.3			
	Detrás/Back	1									
	Arriba/Top	1	RR-0285-PC	01.07.2782.PC	12.7	1/2	275.5	16.8			
	Abajo/Bottom	1	RR-0286-PC	01.07.2783.PC	19.0	3/4	275.5	16.8			
	Izquierda/Left	1	RR-2748-PC	01.07.2813.PC	25.4	1	234.5	14.3			
	Derecha/Right	1									
	Arriba/Top	2	RR-0287-PC	01.07.2784.PC	12.7	1/2	267.3	16.3			
	Abajo/Bottom	2	RR-0288-PC	01.07.2785.PC	19.0	3/4	267.3	16.3			
	Detrás/Back	1									
	Arriba/Top	1	RR-0289-PC	01.07.2786.PC	12.7	1/2	267.3	16.3			
	Abajo/Bottom	1	RR-0290-PC	01.07.2787.PC	19.0	3/4	267.3	16.3			
	Izquierda/Left	2									
	Derecha/Right	1									
	Detrás/Back	1									

Certificaciones / Compliances: Expediente/File No. LR 105795-1

Expediente/File No. E135600

Cajas 25.4 1"
 Boxes 25.4 1"

Especificaciones sujetas a cambio sin previo aviso. Specifications are subject to change without notice.

RAWELT, S.A. de C.V.

RAWELT INYECTADOS

Una División del Grupo **REVUELTA**

22 - V - 2009

**3.3 - CAJA RECTANGULAR. A PRUEBA DE INTEMPERIE. SERIE RR.
CON RECUBRIMIENTO EXTERIOR DE PVC E INTERIOR DE URETANO PURPURA.**

Hoja: 3 / 4
Page:

**3.3 - WEATHERPROOF SINGLE GANG BOX. RR SERIES.
WITH PVC COATING AND PURPLE URETHANE INNER COATING.**

FICHA TECNICA / TECHNICAL DATA

007-RW-197

TAPA

- Recubrimiento PVC: 40 mil. mínimo.
- Uretano PURPURA: 2 mil. mínimo.
- Lámina de aluminio troquelada.
- Tornillos de acero inoxidable incluidos.

COVER

- PVC coating: 40 mil. min.
- PURPLE Urethane: 2 mil. min.
- Sheet aluminum.
- Stainless steel screws included.

CLOSE UP PLUG

- Die cast aluminum.

TAPON

- Aluminio inyectado a presión (diecast).

Dimensiones en milímetros y pulgadas.
Dimensions in inches and millimeters.

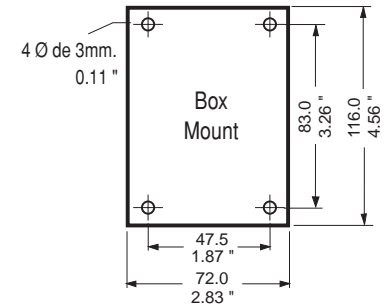
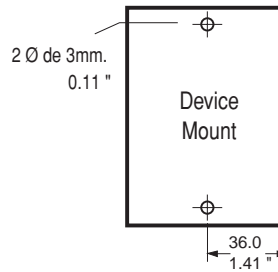

LISTED
1M70



USAR No. DE CODIGO PARA HACER PEDIDOS / TO ORDER USE CODE NUMBER

Figura Figure	Catálogo Catalog	Código Code	Descripción Description	Cant. Diam. Qty.	Espesor Thickness		Peso x 100 pzas. Weight x 100 pcs.		Unit. Ctn. Pzas. Pcs.	Ship Ctn. Pzas. Pcs.	Std Pkg. Pzas. Pcs.
					mm	inch	kg	Lb			
	TR-0424-PC	01.08.2822.PC	Tapa rectangular para contacto de 35.23 mm Ø 1 3/8". Single gang round receptacle cover 1 3/8" diameter hole. Box mount.	4	1.02	.040			50	150	
	TR-0414-PC	01.08.2815.PC	Tapa rectangular para contacto de 40.38 mm Ø 1 9/16". Single gang round receptacle cover 1 9/16" diameter hole. Box mount.	4	1.02	.040			50	150	
	TR-0426-PC	01.08.2824.PC	Tapa rectangular para contacto de 35.23 mm Ø 1 3/8". Single gang round receptacle cover 2 1/8" diameter hole. Box mount.	4	1.02	.040			50	150	
	TR-0425-PC	01.08.2823.PC	Tapa rectangular para contacto de 35.23 mm Ø 1 3/8". Single gang round receptacle cover 1 3/8" diameter hole. Device mount.	2	1.02	.040			50	150	
	TR-0423-PC	01.08.2821.PC	Tapa rectangular para contacto de 40.38 mm Ø 1 9/16". Single gang round receptacle cover 1 9/16" diameter hole. Device mount.	2	1.02	.040			50	150	
	TR-0427-PC	01.08.2825.PC	Tapa rectangular para contacto de 54.30 mm Ø 2 1/8". Single gang round receptacle cover 2 1/8" diameter hole. Device mount.	2	1.02	.040			50	150	
	TR-0415-PC	01.08.2816.PC	Tapa rectangular para interruptor Single gang toggle switch cover. Box mount.	4	1.02	.040			50	150	

Especificaciones sujetas a cambio sin previo aviso. Specifications are subject to change without notice..

RAWELT, S.A. de C.V.



Una División del Grupo REVUELTA

16 - VI - 2009

**3.3 - CAJA RECTANGULAR. A PRUEBA DE INTEMPERIE. SERIE RR.
CON RECUBRIMIENTO EXTERIOR DE PVC E INTERIOR DE URETANO PURPURA.**

**3.3 - WEATHERPROOF SINGLE GANG BOX. RR SERIES.
WITH PVC COATING AND PURPLE URETHANE INNER COATING.**

Hoja: 4 / 4
Page:

FICHA TECNICA / TECHNICAL DATA

007-RW-197

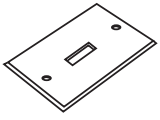
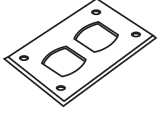
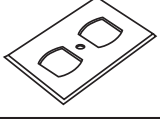
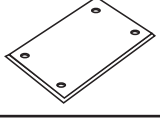
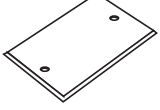

USAR No. DE CODIGO PARA HACER PEDIDOS / TO ORDER USE CODE NUMBER

Figura Figure	Catálogo Catalog	Código Code	Descripción Description	Cant. Diam. Qty.	Espesor Thickness		Peso x 100 pzas. Weight x 100 pcs.		Unit. Ctn. Pzas. Pcs.	Ship Ctn. Pzas. Pcs.	Std. Pkg. Pzas. Pcs.
					mm	inch	kg	Lb			
	TR-0421-PC	01.08.2819.PC	Tapa rectangular para interruptor Single gang toggle switch cover. Device mount.	2	1.02	.040			50	150	
	TR-0385-PC	01.08.2814.PC	Tapa rectangular para contacto duplex. Single gang duplex receptacle cover. Box mount.	4	1.02	.040	2.0	4.4	50	150	
	TR-0422-PC	01.08.2820.PC	Tapa rectangular para contacto duplex. Single gang duplex receptacle cover. Device mount.	1	1.02	.040	1.9	4.2	50	150	
	TR-0416-PC	01.08.2817.PC	Tapa rectangular ciega. Weatherproof single gang blank cover. Box mount.	4	1.02	.040	2.4	5.3	50	150	
	TR-0420-PC	01.08.2818.PC	Tapa rectangular ciega. Weatherproof single gang blank cover. Device mount.	2	1.02	.040	2.4	5.3	50	150	

TAPONES / PLUGS

USAR No. DE CODIGO PARA HACER PEDIDOS / TO ORDER USE CODE NUMBER

Figura Figure	Catálogo Catalog	Código Code	Descripción Description	Medida nominal Hub size		Peso x 100 pzas. Weight x 100 pcs.		Pqt. Unit Pzas. Pcs.	Unit Ctn. Pzas. Pcs.	Ship Ctn. Pzas. Pcs.
				mm.	inch	Kg	Lb			
	TA-0371-EX	01.09.2829.EX	Tapón roscado.	12.7	1/2			25	200	2000
	TA-0368-EX	01.09.2828.EX	Close-up plug.	19.0	3/4			25	100	1000
	TA-2632-EX	01.09.2830.EX		25.4	1			25	100	1000

Certificaciones / Compliances:  Expediente/File No. LR 105795-1  Expediente/File No. E135600
 Tapones
 Closure plugs

Especificaciones sujetas a cambio sin previo aviso. Specifications are subject to change without notice.

RAWELT, S.A. de C.V.

 **RAWELT** INYECTADOS
Una División del Grupo 

16 - VI - 2009



Cotización/Quotation Plazo de embarque* / Shipment exw* :

Pedido No./Purchase order :

Our ref.:

Fecha/Date: Vendedor/Salesman:

No.

Facturar a/Invoice to:

RFC.

Ordenado por/Ordered by: Tel. ()

Fax ()

Dirección/Address:

C.P./Zip. Lugar/City/Country:

Consignar a/Ship to:

Embarcar: Camión x Cobrar Pagado Paquete

Cond. de Pago/Terms:

Cond. de Venta/Sale conditions: L.P.:

3.3 - SERIE RR - PC. CAJA RECTANGULAR A PRUEBA DE INTEMPERIE. CON PVC / WEATHERPROOF SINGLE GANG BOX WITH PVC COATING.														
Figura Figure	Código Code	Medida nominal Hub size		Pqt. Unit. Pzas. Pcs.	Unit. Ctn. Pzas. Pcs.	Ship Ctn. Pzas. Pcs.	Std. Pkg. Pzas. Pcs.	Cantidad Qty.	Figura Figure	Código Code	Medida nominal Hub size		Std. Pkg. Pzas. Pcs.	Cantidad Qty.
		mm	inch								mm	inch		
	01.07.2802.PC	12.7	1/2				30		01.07.2804.PC	12.7	1/2			
	01.07.2803.PC	19.0	3/4				30		01.07.2805.PC	19.0	3/4			
	01.07.2806.PC	25.4	1				30		01.07.2810.PC	25.4	1			
	01.07.2790.PC	12.7	1/2				30		01.07.2778.PC	12.7	1/2			
	01.07.2791.PC	19.0	3/4				24		01.07.2779.PC	19.0	3/4			
	01.07.2807.PC	25.4	1				24		01.07.2811.PC	25.4	1			
	01.07.2792.PC	12.7	1/2				30		01.07.2780.PC	12.7	1/2			
	01.07.2793.PC	19.0	3/4				24		01.07.2781.PC	19.0	3/4			
	01.07.2800.PC	12.7	1/2				26		01.07.2788.PC	12.7	1/2			
	01.07.2801.PC	19.0	3/4				20		01.07.2789.PC	19.0	3/4			
	01.07.2808.PC	25.4	1				20		01.07.2812.PC	25.4	1			
	01.07.2794.PC	12.7	1/2				20		01.07.2782.PC	12.7	1/2			
	01.07.2795.PC	19.0	3/4				16		01.07.2783.PC	19.0	3/4			
	01.07.2809.PC	25.4	1				16		01.07.2813.PC	25.4	1			
	01.07.2796.PC	12.7	1/2				30		01.07.2784.PC	12.7	1/2			
	01.07.2797.PC	19.0	3/4				24		01.07.2785.PC	19.0	3/4			
	01.07.2798.PC	12.7	1/2				20		01.07.2786.PC	12.7	1/2			
	01.07.2799.PC	19.0	3/4				16		01.07.2787.PC	19.0	3/4			
	01.09.2829.PC	12.7	1/2	25	200	2000								
	01.09.2828.PC	19.0	3/4	25	100	1000								
	01.09.2830.PC	25.4	1	25	100	1000								

Expediente
 Control
 Embarques
 Almacén
 Producción

- Antes de fincar el pedido en firme, favor de confirmar con fábrica el plazo de embarque definitivo.
- Before place your order, please confirm with RAWELT definitive date of shipment.



Cotización/Quotation Plazo de embarque* / Shipment exw*

Pedido No./Purchase order : _____ Our ref.: _____

Fecha/Date: _____ Vendedor/Salesman: _____ No. _____

Facturar a/Invoice to: _____ RFC. _____

Ordenado por/Ordered by: _____ Tel. () _____ Fax () _____

Dirección/Address: _____

C.P./Zip. _____ Lugar/City/Country: _____

Consignar a/Ship to: _____

Embarcar: Camión x Cobrar Pagado Paquete

Cond. de Pago/Terms: _____

Cond. de Venta/Sale conditions: _____ L.P.: _____

3.3 - SERIE RR-PC. TAPA PVC / COVER WITH PVC COATING							4.3 - SERIE RC-PC. TAPA PVC / COVER WITH PVC COATING						
Figura Figure	Código Código	Diametro Diameter	Unit. Ctn.	Ship Ctn.	Std. Pkg. Pzas. Pcs.	Cantidad Qty.	Figura Figure	Código Code	Unit. Ctn.	Ship Ctn.	Std. Pkg. Pzas. Pcs.	Cantidad Qty.	
	01.08.2822.PC	Ø 35.23 mm	50	150				02.07.2875.PC	30	90			
	01.08.2815.PC	Ø 40.38 mm	50	150					02.07.2878.PC	30	90		
	01.08.2824.PC	Ø 54.30 mm	50	150						02.07.2877.PC	30	90	
	01.08.2823.PC	Ø 35.23 mm	50	150						02.07.2880.PC	30	90	
	01.08.2821.PC	Ø 40.38 mm	50	150						02.07.2881.PC	30	90	
	01.08.2825.PC	Ø 54.30 mm	50	150						02.07.2882.PC	30	90	
	01.08.2816.PC		50	150						02.07.2876.PC	30	90	
	01.08.2819.PC		50	150						02.07.2879.PC	30	90	
	01.08.2814.PC		50	150									
	01.08.2820.PC		50	150									
	01.08.2817.PC		50	150									
	01.08.2818.PC		50	150									

Expediente
 Control
 Embarques
 Almacén
 Producción

- Antes de fincar el pedido en firme, favor de confirmar con fábrica el plazo de embarque definitivo.
- Before place your order, please confirm with RAWELT definitive date of shipment.