



PURPURA[®] COAT

RECUBRIMIENTO DE PVC



Luminarias HID con recubrimiento exterior de PVC e interior de URETANO PURPURA.



Sellos para áreas peligrosas con recubrimiento exterior de PVC e interior de URETANO PURPURA.



Tubo Conduit rígido de aluminio desnudo ó con recubrimiento exterior de PVC e interior de URETANO PURPURA.



Productos para instalaciones eléctricas. *Products for electrical installations*

CAJAS OVALES
CONDUIT OUTLET BOXES

CAJAS RECTANGULARES y CUADRADAS
A prueba de intemperie
WEATHERPROOF OUTLET BOXES

CAJAS REDONDAS A PRUEBA DE INTEMPERIE
WEATHERPROOF ROUND OUTLET BOXES

CAJAS PARA AREAS PELIGROSAS
HAZARDOUS LOCATIONS CONDUIT OUTLET BOXES

SELLOS. Para áreas peligrosas
SEALING FITTINGS. For hazardous locations

TUERCAS UNION. Para áreas peligrosas
CONDUIT UNIONS. For hazardous locations

TUBERIA CONDUIT DE ALUMINIO
ALUMINUM RIGID CONDUIT

LAMPARAS A PRUEBA DE VAPOR
VAPORTIGHT LIGHTING FIXTURES

LAMPARAS A PRUEBA DE EXPLOSION
EXPLOSIONPROOF LIGHTING FIXTURES

LAMPARAS LUZ DE OBSTRUCCION
OBSTRUCTION MARKER LIGHT

LAMPARAS HID. Para áreas peligrosas
HID LIGHTING FIXTURES. For hazardous locations

PORTALAMPARAS A PRUEBA DE INTEMPERIE
WEATHERPROOF LAMP HOLDERS

CAJAS DE UNION
JUNCTION BOXES

POLEAS
PULLEYS

CAJAS APILABLES
STORAGE BINS

Fabricante:
RAWELT, S.A. de C.V.
Distribuidor para México:
BASCULAS REVUELTA, S.A. de C.V.
Torreón, Coah., México.
E-mail: rawelt_trc@revuelta.com.mx
www.rawelt.com.mx

Tel.: (871) 747-4747
Fax: (871) 747-4748

LADA SIN COSTO: 01-800-7117-200 (Para México)

INYECTADOS



Una División del Grupo REVUELTA

**6.2 - SELLOS PARA AREAS PELIGROSAS. LIBRE DE COBRE
CON RECUBRIMIENTO EXTERIOR DE PVC E INTERIOR DE URETANO PURPURA.**
**6.2 - SEALING FITTINGS FOR HAZARDOUS LOCATIONS. COPPER FREE ALUMINUM.
WITH PVC COATING AND PURPLE URETHANE INNER COATING.**

Para dimensiones:
Ver Ficha Tecnica 007 - RW - 265
Clase I, Div. 1 y 2, grupos A, B, C, D.
Clase II, Div. 1 y 2, grupos E, F, G.
Clase III, Div. 1 y 2.

*** Ver nota abajo**

APLICACIONES:

- A prueba de áreas corrosivas.
- Recubrimiento PVC: 40 mil. mínimo.
- Uretano PURPURA: 2 mil. mínimo.
- Mangas en las entradas para un sellado hermético.
- Impiden el paso de gases, vapores y flamas de una parte de la instalación eléctrica a otra de presión atmosférica y temperatura ambiente normales.
- Rosca NPT para usarse con tubo conduit RIGIDO.
- Posiciones: vertical u horizontal.

MATERIAL

- Aluminio libre de cobre inyectado a presión (Diecast).

OPCIONAL

- Niple removible de acero galvanizado y recubierto de Uretano.

INSTRUCCIONES

- Deberán colocarse a una distancia no mayor de 457 mm (18") de cualquier aparato que provoque chispas, arcos ó altas temperaturas.
- El espesor del cemento sellador no deberá de ser menor del diámetro de la tubería y en ningún caso menor a 16 mm (5/8").
- Fabricación en base a: UL 886
CAN/CSA - C22.2 No. 30
UL 1203



For dimensions:
See Technical Data 007 - RW - 265
Class I, Div. 1 & 2, groups A, B, C, D.
Class II, Div. 1 & 2, groups E, F, G.
Class III, Div. 1 & 2.

*** See note below**

APPLICATIONS:

- For use in corrosive atmospheres.
- PVC coating: 40 mil. min.
- PURPLE Urethane: 2 mil. min.
- Pressure sealing sleeves on conduit openings.
- Restrict the passage of gases, vapors, liquids, dust and flames from one portion of the electrical installation to another at atmospheric pressure and normal ambient temperatures.
- NPT threaded for use with RIGID conduit.
- Vertical and Horizontal positions.

MATERIAL

- Diecast copper free aluminum

OPTIONAL

- Galvanized removable Nipple with Urethane coating.

INSTRUCTIONS

- Are to be installed within 18" of a device that produce sparks, arcs or high temperature.
- The thickness of the sealing compound shall not be less than the trade size of conduit and in no case less than 5/8".
- Manufactured in compliance with: UL 886
CAN/CSA - C22.2 No.30
UL 1203

CERTIFICACIONES / COMPLIANCES: CSA LR - 105795 - 6
UL E1 98859

USAR No. DE CODIGO PARA HACER PEDIDOS / TO ORDER USE CODE NUMBER

Figura Figure	Catalogo Catalog	Codigo Code	Medida nominal Hub size		Tapón llenado Filling plug mm / inch		Numero y tamaño de conductor Number and size of conductor THW	Peso x 100 pzas. Weight x 100 pcs.		Unit Ctn. Pzas. Pcs.	Ship Ctn. Pzas. Pcs.	Std. Pkg. Pzas. Pcs.
			mm.	inch	horiz.	vert.		kg	Lb			
	EYS-0452-PC	04.12.2328.PC	12.7	1/2	19.0 3/4	6.35 1/4	7 # 18 AWG	25.56	56.23			60
	EYS-0453-PC	04.12.2333.PC	19.0	3/4	19.0 3/4	6.35 1/4	10 # 16 AWG	20.32	44.70			60
	EYS-0550-PC	04.12.2338.PC	25.4	1	25.4 1	6.35 1/4	10 # 14 AWG	39.60	87.12			35
	EYS-2633-PC	04.12.2909.PC	31.75	1 1/4	31.75 1 1/4	12.7 1/2	13 # 10 AWG					18
	EYS-2634-PC	04.12.2910.PC	38.1	1 1/2	38.1 1 1/2	19.0 3/4	10 # 8 AWG	76.99	169.38			13
	EYS-2635-PC	04.12.2911.PC	50.8	2	50.8 2	19.0 3/4	10 # 6 AWG	117.53	259.1			6

*** UL LISTED:** EYS-0452, EYS-0453 and EYS-0550 for use in **Class I** Div. 1 & 2, group C,D. **Class II** Div. 1 & 2, group E,F,G. **Class III** Div. 1 & 2.

CSA STD CSA-C22.2 No.30

CERTIFIED: EYS-0452, EYS-0453, EYS-0550, EYS-2633, EYS-2634 and EYS-2635 for use in **Class I** Div. 1 & 2, group A,B,C,D. **Class II** Div. 1 & 2, group E,F,G. **Class III** Div. 1 & 2.

CSA US STD UL 1203

CERTIFIED: EYS-2633, EYS-2634 and EYS-2635 for use in **Class I** Div. 1 & 2, group C,D. **Class II** Div. 1 & 2, group E,F,G. **Class III** Div. 1 & 2.

Especificaciones sujetas a cambio sin previo aviso. Specifications are subject to change without notice.

RAWELT, S.A. de C.V.

RAWELT INYECTADOS
Una División del Grupo **REVUELTA**

**6.2 - SELLOS PARA AREAS PELIGROSAS. LIBRE DE COBRE
CON RECUBRIMIENTO EXTERIOR DE PVC E INTERIOR DE URETANO PURPURA.**
**6.2 - SEALING FITTINGS FOR HAZARDOUS LOCATIONS. COPPER FREE ALUMINUM.
WITH PVC COATING AND PURPLE URETHANE INNER COATING.**

Hoja: 2 / 3
Page:

FICHA TECNICA / TECHNICAL DATA
007 - RW - 141

USAR No. DE CODIGO PARA HACER PEDIDOS / TO ORDER USE CODE NUMBER

Figura Figure	Catalogo Catalog	Codigo Code	Medida nominal Hub size		Tapón llenado Filling plug mm. / inch		Numero y tamaño de conductor Number and size of conductor THW	Peso x 100 pzas. Weight x 100 pcs.		Unit Ctn. Pzas. Pcs.	Ship Ctn. Pzas. Pcs.	Std. Pkg. Pzas. Pcs.
			mm.	inch	horiz.	vert.		kg	Lb			
	EYS-0452-NP	04.12.2906.NP	12.7	1/2	19.0 3/4	6.35 1/4	7 # 18 AWG					48
	EYS-0453-NP	04.12.2907.NP	19.0	3/4	19.0 3/4	6.35 1/4	10 # 16 AWG					48
	EYS-0550-NP	04.12.2908.NP	25.4	1	25.4 1	6.35 1/4	10 # 14 AWG					24
	EYS-2633-NP	04.12.2912.NP	31.75	1 1/4	31.75 1 1/4	12.7 1/2	13 # 10 AWG					18
	EYS-2634-NP	04.12.2913.NP	38.1	1 1/2	38.1 1 1/2	19.0 3/4	10 # 8 AWG					8
	EYS-2635-NP	04.12.2914.NP	50.8	2	50.8 2	19.0 3/4	10 # 6 AWG					6

USAR No. DE CODIGO PARA HACER PEDIDOS / TO ORDER USE CODE NUMBER

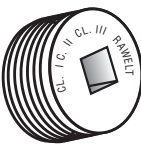
Figura Figure	Catalogo Catalog	Codigo Code	Medida nominal Hub size		Tapón / Close-up plug	Peso x 100 pzas. Weight x 100 pcs.		Pqt. Unit Pzas. Pcs.	Unit Ctn. Pzas. Pcs.	Ship Ctn. Pzas. Pcs.
			mm.	inch		kg	Lb			
	TA-2939-EX	04.25.2946.EX	6.35	1/4	Vaciado vertical Vertical filling	0.900	1.98	25		
	TA-2943-EX	04.25.2950.EX	12.7	1/2	Vertical filling	0.835	1.80	25		
	TA-2938-EX	04.25.2945.EX	19.0	3/4	Vaciado vert. y horiz. / Vert. & hor. filling	1.700	3.75	25		
	TA-2937-EX	04.25.2944.EX	25.4	1	Vaciado horizontal Horizontal filling	2.720	6.00	20		
	TA-2636-EX	04.25.2947.EX	31.75	1 1/4		3.900	8.60	10		
	TA-2637-EX	04.25.2948.EX	38.1	1 1/2	5.960	13.10	10			
	TA-2638-EX	04.25.2949.EX	50.8	2	8.540	18.80	10			



**COMPUESTO SELLADOR Y FIBRA.
SEALING COMPOUND AND FIBER.**



- El compuesto sellador RAWELT es usado para impedir el paso de gases, vapores o flamas de una instalación eléctrica a otra de presión atmosférica y temperatura ambiente normales.
- La fibra es utilizada para crear una obstrucción para impedir escurrimientos a la tubería cuando se vierte el compuesto en el sello.
- El compuesto sellador RAWELT se expande ligeramente para formar un sello completamente hermético.
- Es resistente a solventes, ácidos, agua y aceites.
- Tiempo de curado: 12 horas a 20°C.

- The sealing compound RAWELT is used to restrict the passage of gases, vapors or flames from one portion of the electrical installation to another at atmospheric pressure and normal ambient temperatures.
- The fiber is used to form a dam to restrict drains to the conduit when pour the sealing compound in the sealing fitting.
- The sealing compound RAWELT expands slightly to form a seal completely hermetic.
- Is resistant to solvents, acids, water and oil.
- Curing time: 12 hours at 68°F.

USAR No. DE CODIGO PARA HACER PEDIDOS / TO ORDER USE CODE NUMBER

Figura Figure	Catalogo Catalog	Codigo Code	Peso neto del producto Net weight of product		Volumen al curar Volume when set		Unit Ctn. Pzas. Pcs.	Ship Ctn. Pzas. Pcs.	Std. Pkg. Pzas. Pcs.
			kg	lb	cm ³	cu. in			
	CE-2571	04.22.2571	1 kg*	2.20 lb	833	50.8			10
	FB-06	04.22.2578	60 g	2.11 oz					40
	FB-10	04.22.2579	100 g	3.52 oz					36
	FB-25	04.22.2580	250 g	8.81 oz					14
	FB-50	04.22.2581	500 g	1.10 lb					5

- La presentación de 1 Kg se surte con 60 g de fibra. / The container of 2 lb. includes 2 Oz. of fiber.
Especificaciones sujetas a cambio sin previo aviso. Specifications are subject to change without notice.

RAWELT, S.A. de C.V.



Una División del Grupo REVUELTA

22 - V - 2009

**6.2 - SELLOS PARA AREAS PELIGROSAS. LIBRE DE COBRE
CON RECUBRIMIENTO EXTERIOR DE PVC E INTERIOR DE URETANO PURPURA.**
**6.2 - SEALING FITTINGS FOR HAZARDOUS LOCATIONS. COPPER FREE ALUMINUM.
WITH PVC COATING AND PURPLE URETHANE INNER COATING.**

Hoja: 3 / 3
Page:

FICHA TECNICA / TECHNICAL DATA

007-RW-141

NIPLES / NIPPLES

USAR No. DE CODIGO PARA HACER PEDIDOS / TO ORDER USE CODE NUMBER

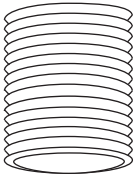
Figura Figure	Catalogo Catalog	Codigo Code	Medida nominal Hub size		Peso x 100 pzas. Weight x 100 pcs.		Pqt. Unit. Pzas. Pcs.	Unit Ctn. Pzas. Pcs.	Ship Ctn. Pzas. Pcs.	Std. Pkg. Pzas. Pcs.
			mm	inch.	Kg	Lb				
				NI-13-EX	04.28.3236.EX	12.7				
	NI-19-EX	04.28.3237.EX	19.0	3/4			25			
	NI-25-EX	04.28.3238.EX	25.4	1			25			
	NI-32-EX	04.28.3239.EX	31.7	1 1/4			10			
	NI-38-EX	04.28.3240.EX	38.1	1 1/2			10			
	NI-50-EX	04.28.3241.EX	50.8	2			10			

RAWELT, S.A. de C.V.

 **RAWELT**® INYECTADOS

Una División del Grupo  **REVUELTA**

04 - IX - 2007

6.2 - SELLOS PARA AREAS PELIGROSAS. SERIE EYS.
PREPARACION DEL CEMENTO SELLADOR

6.2 - SEALING FITTINGS FOR HAZARDOUS LOCATIONS. EYS SERIES.
PREPARATION OF THE SEALING COMPOUND.

- El compuesto sellador **RAWELT** es usado para impedir el paso de gases, vapores o flamas de una instalación eléctrica a otra de presión atmosférica y temperatura ambiente normales.
- La fibra es utilizada para crear una obstrucción para impedir escurrimientos a la tubería cuando se vierte el compuesto en el sello.
- El compuesto sellador **RAWELT** se expande ligeramente para formar un sello completamente hermético.
- The sealing compound **RAWELT** is used to restrict the passage of gases, vapors or flames from one portion of the electrical installation to another at atmospheric pressure and normal ambient temperatures.
- The fiber is used to form a dam to restrict drains to the conduit when pour the sealing compound in the sealing fitting.
- The sealing compound **RAWELT** expands slightly to form a seal completely hermetic.

Taponeado y vaciado
Damming and Pouring

Posición Horizontal
Horizontal Position

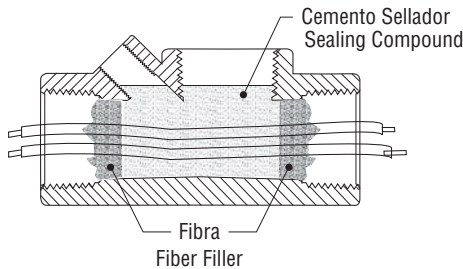

Clase I, Div. 1 y 2, grupo A, B, C, D.
Clase II, Div. 1 y 2, grupo E, F, G.
Clase III, Div 1 y 2.

*** Ver nota abajo**

Class I, Div. 1 & 2, group A, B, C, D.
Class II, Div. 1 & 2, group E, F, G.
Class III, Div. 1 & 2.

*** See note below**

Taponeado y vaciado
Damming and Pouring

Posición Vertical
Vertical Position

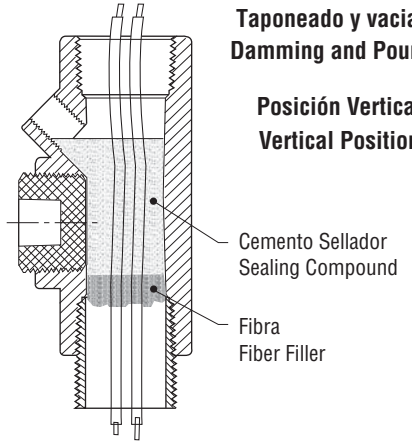

INSTRUCCIONES: Agite la lata para mezclar perfectamente el contenido antes de cada uso.

- Separe cada conductor, empaque la fibra apretándola alrededor de cada conductor, y entre las paredes del sello. Los conductores no deben de tocarse entre sí, ni tampoco a las paredes del sello.
- Añada 1 parte de agua fría por 3 partes de compuesto por volumen; mezcle perfectamente y deposítelo en el sello usando una varilla para distribuir la mezcla dentro del sello no dejando ninguna burbuja en el compuesto sellador hasta que el compuesto este a la altura de el último hilo de la boca pequeña en la posición vertical y hasta 2 hilos cubiertos en la posición horizontal; ciérrelo con el tapón roscado inmediatamente después de vaciado.

PRECAUCIONES: Cierre la lata de compuesto perfectamente después de cada uso; el manejo incorrecto del compuesto, su mala aplicación, las condiciones ambientales e impurezas, pueden causar un sellado defectuoso.

- No use la mezcla después de 15 minutos de haber vaciado el agua, ni la prepare a temperaturas menores de 1.7°C. (35°F). Si el compuesto empieza a secarse, no intente rebajarlo con agua o revolviendolo, esto arruina el compuesto.
- El tiempo de curado dependerá de la temperatura ambiente. Aproximadamente: 12 horas a 20°C. (68°F); 72 horas a 4.4°C (40°F).
- Para instalaciones de GRUPO A, el compuesto sellador deberá tener un tiempo de curado de 72 horas, antes de energizar el sistema.
- Resistente a solventes, ácidos, agua y aceites.

INSTRUCCIONES: Mix and shake perfectly contents before each use.

- Separate each conductor, pack the fiber around and between each conductor and wall of the fitting. The conductor must not touch one another nor touch the wall of the fitting.
- Add 1 part of cold water to 3 parts compound by volume, thoroughly stir and pour it thoroughly into sealing fitting carefully using a stick to distribute into it until the compound is level with the last thread of the opening for the vertical conduit and until 2 threads are covered of the horizontal conduit. Be sure do not leave any bubbles into the sealing compound. Close with the plugs the sealing fitting after pouring.

CAUTION: Close firmly the container lid after each use; the wrong handling, failure in applications, humid or moisture conditions and impurities may produce a faulty seal.

- Do not mix the compound with water in amounts, than can not be use within 15 minutes, nor temperatures below 35°F (1.7°C). If the compound starts to set do not attempt to thin it by adding water or by stirring, this procedure spoil the compound.
- The curing time depends with the temperature. For example: 68°F (20°C) - 12 hours., 40°F (4.4°C) - 72 hours.
- For group A installations, sealing compound must be allowed 72 hours to cure.
- Resistant to solvents, acids, water and oil.

DIAMETRO ENTRADAS / NUMERO Y TAMAÑO DEL CONDUCTOR THW	1/2 7 # 18 AWG	1 1/4 13 # 10 AWG
Hub Size / Number and size of conductor TWH	3/4 10 # 16 AWG	1 1/2 10 # 8 AWG
	1 10 # 14 AWG	2 10 # 6 AWG

*** UL LISTED:** EYS-0452, EYS-0453 and EYS-0550 for use in **Class I** Div. 1 & 2, group C,D. **Class II** Div. 1 & 2, group E,F,G. **Class III** Div. 1 & 2.



CERTIFIED: EYS-0452, EYS-0453, EYS-0550, EYS-2633, EYS-2634 and EYS-2635 for use in **Class I** Div. 1 & 2, group A,B,C,D. **Class II** Div. 1 & 2, group E,F,G. **Class III** Div. 1 & 2.



CERTIFIED: EYS-2633, EYS-2634 and EYS-2635 for use in **Class I** Div. 1 & 2, group C,D. **Class II** Div. 1 & 2, group E,F,G. **Class III** Div. 1 & 2.

RAWELT, S.A. de C.V.



Una División del Grupo **REVELTA**

6.2 - SELLOS PARA AREAS PELIGROSAS. LIBRE DE COBRE.
CON RECUBRIMIENTO EXTERIOR DE PVC E INTERIOR DE URETANO PURPURA.

6.2 - SEALING FITTINGS FOR HAZARDOUS LOCATIONS. COPPER FREE ALUMINUM.
WITH PVC COATED AND PURPLE URETHANE INNER COATING.

Hoja: 2 / 2
 Page:

FICHA TECNICA / TECHNICAL DATA

007-RW-265

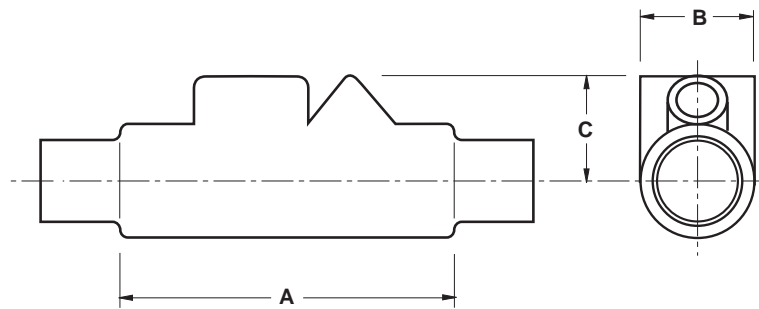

SELLO HEMBRA PVC		PVC FEMALE SEALING FITTING											
Catalogo Catalog	Código Code	Medida Nominal Hub size		A		B		Radio de giro Turning radius C		Cemento sellador requerido Sealing cement required		Fibra requerida por pieza Fiber required required by pc.	
		mm	Inch.	mm	Inch.	mm	Inch.	mm	Inch.	g	oz	g	oz
EYS-0452-PC	04.12.2328.PC	12.7	1/2	97	3.82	38	1.50	34	1.34	50	1.75	1.00	0.036
EYS-0453-PC	04.12.2333.PC	19.0	3/4	97	3.82	38	1.50	34	1.34	71	2.50	1.70	0.060
EYS-0550-PC	04.12.2338.PC	25.4	1	108	4.25	48	1.89	39	1.54	100	3.50	3.70	0.130
EYS-2633-PC	04.12.2909.PC	31.75	1 1/4	125	4.92	55	2.17	46	1.81	255	9.02	7.08	0.250
EYS-2634-PC	04.12.2910.PC	38.1	1 1/2	140	5.51	62	2.44	56	2.20	340	12.00	14.17	0.500
EYS-2635-PC	04.12.2911.PC	50.8	2	152	6.00	78	3.07	61	2.40	595	21.00	28.34	1.00

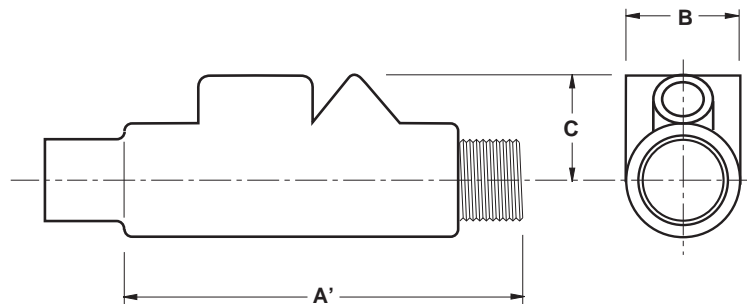

SELLO MACHO-HEMBRA PVC		PVC MALE-FEMALE SEALING FITTING											
Catalogo Catalog	Código Code	Medida Nominal Hub size		A'		B		Radio de giro Turning radius C		Cemento sellador requerido Sealing cement required		Fibra requerida por pieza Fiber required required by pc.	
		mm	Inch.	mm	Inch.	mm	Inch.	mm	Inch.	g	oz	g	oz
EYS-0452-NP	04.12.2906.PC	12.7	1/2	130	5.12	38	1.50	34	1.34	50	1.75	1.00	0.036
EYS-0453-NP	04.12.2907.PC	19.0	3/4	130	5.12	38	1.50	34	1.34	71	2.50	1.70	0.060
EYS-0550-NP	04.12.2908.PC	25.4	1	147	5.79	48	1.89	39	1.54	100	3.50	3.70	0.130
EYS-2633-NP	04.12.2912.PC	31.75	1 1/4	166	6.54	55	2.17	46	1.81	255	9.02	7.08	0.250
EYS-2634-NP	04.12.2913.PC	38.1	1 1/2	185	7.28	62	2.44	56	2.20	340	12.00	14.17	0.500
EYS-2635-NP	04.12.2914.PC	50.8	2	200	7.87	78	3.07	61	2.40	595	21.00	28.34	1.00

RAWELT, S.A. de C.V.



Una División del Grupo **REVELTA**

22 - V - 2009

Cotización/Quotation Plazo de embarque* / Shipment exw* :

Pedido No./Purchase order :

Our ref.:

Fecha/Date: Vendedor/Salesman: No.

Facturar a/Invoice to: RFC:

Ordenado por/Ordered by: Tel. () Fax ()

Dirección/Address:

C.P./Zip. Lugar/City/Country:

Consignar a/Ship to:

Embarcar: Camión x Cobrar Pagado Paquete

Cond. de Pago/Terms:

Cond. de Venta/Sale conditions: L.P.:

6.2 - SERIE EYS. SELLOS PARA AREAS PELIGROSAS/SEALING FITTINGS FOR HAZARDOUS LOCATIONS.								
Figura Figure	Código Code	Medida nominal Hub size		Pqt. Unit.	Unit. Ctn.	Ship Ctn.	Std. Pkg.	Cantidad Qty.
		mm	inch	Pzas. Pcs.	Pzas. Pcs.	Pzas. Pcs.	Pzas. Pcs.	
	04.12.2328.PC	12.7	1/2				60	
	04.12.2333.PC	19.0	3/4				60	
	04.12.2338.PC	25.4	1				35	
	04.12.2909.PC	31.7	1 1/4				18	
	04.12.2910.PC	38.1	1 1/2				13	
	04.12.2911.PC	50.8	2				6	
	04.12.2906.NP	12.7	1/2				48	
	04.12.2907.NP	19.0	3/4				48	
	04.12.2908.NP	25.4	1				24	
	04.12.2912.NP	31.7	1 1/4				18	
	04.12.2913.NP	38.1	1 1/2				8	
	04.12.2914.NP	50.8	2				6	
	04.25.2946.EX	6.35	1/4	25				
	04.25.2950.EX	12.7	1/2	25				
	04.25.2945.EX	19.0	3/4	25				
	04.25.2944.EX	25.4	1	20				
	04.25.2947.EX	31.7	1 1/4	10				
	04.25.2948.EX	38.1	1 1/2	10				
	04.25.2949.EX	50.8	2	10				
	04.28.3236.EX	12.7	1/2	25				
	04.28.3237.EX	19.0	3/4	25				
	04.28.3238.EX	25.4	1	25				
	04.28.3239.EX	31.7	1 1/4	10				
	04.28.3240.EX	38.1	1 1/2	10				
	04.28.3241.EX	50.8	2	10				
	*04.22.2571	Peso / weight					10	
		1 kg						
	04.22.2578	60 g					40	
	04.22.2579	100 g					36	
	04.22.2580	250 g					14	
	04.22.2581	500 g					5	

* La presentación de 1 kg se surte con 60 g de fibra.

CON RECUBRIMIENTO DE PVC.

• Antes de fincar el pedido en firme, favor de confirmar con fábrica el plazo de embarque definitivo.
• Before place your order, please confirm with RAWELT definitive date of shipment.

Producción Almacén Embarques Control Expediente

Cliente

Ing. de Ventas