

Roxtec ComSeal™



EN The Roxtec ComSeal™ is a light-weight and area efficient cable sealing solution for cabinets. The frames are made out of cast aluminum and the solutions are approved for IP 55 and UL/NEMA 12, 12K. They are equipped with adaptable sealing modules and supplied as readymade kits.

- Available in six different sizes
- For use with Group CM components
- Attached on inside or outside of cabinet

ES ComSeal™ de Roxtec es una solución de sellado de cables para armarios ligera y eficaz. Los marcos son de aluminio fundido y las soluciones han sido aprobadas como IP 55 y UL/NEMA 12, 12K. Cuentan con módulos adaptables de sellado y se suministran en forma de kits listos para utilizar.

- Disponible en seis tamaños
- Para uso con componentes del Grupo CM
- Para instalación dentro o fuera del armario

CN 烙克赛克 ComSeal™ 是高效利用空间的用于箱柜的轻质电缆密封解决方案。框架采用铸铝制作，并经IP 55和UL/NEMA 12、12K认证。配备可调节的密封模块，并以套件形式供货。

- 6种规格可供选择
- 与 CM 系列产品组件共同使用
- 安装在箱柜的内部或外部

FR Le ComSeal™ Roxtec est une solution d'étanchéité de câble légère et efficace en termes de surface pour les armoires et coffrets. Les cadres sont fabriqués en fonte d'aluminium et les solutions sont certifiées IP 55 et UL / NEMA 12, 12K. Ils sont équipés de modules d'étanchéité adaptables et livrés sous la forme de kits prêts à l'emploi.

- Disponible en six tailles différentes
- A utiliser avec les composants du groupe CM
- A fixer à l'intérieur ou à l'extérieur du boîtier

DE Der Roxtec ComSeal™ AISI 316L ist eine flächeneffiziente Kabeldurchführung für Schränke. Die Rahmen bestehen aus gegossenem Edelstahl gemäß AISI 316 um Korrosionen zu vermeiden. Das Produkt ist nach IP 55 und UL/NEMA 12, 12K zugelassen, verfügt über anpassbare Dichtungsmodule und wird als gebrauchsfertiger Bausatz geliefert.

- Verfügbar in sechs verschiedenen Größen.
- Zur Verwendung mit Komponenten der Gruppe CM
- Zur Anbringung innen oder außen am Schrank

ComSeal™ kit, integrated compression unit, aluminum

ComSeal™ 框架, 集成压紧装置, 铝 ▶ ComSeal™ Rahmen, integrierte Kompressionseinheit, Aluminium ▶ Marcos ComSeal™, unidad de compresión integrada, aluminio ▶ ComSeal™, unité de compression intégrée, aluminium nickelé en surface



ComSeal™ 10



ComSeal™ 12



ComSeal™ 15



ComSeal™ 16



ComSeal™ 30



ComSeal™ 32

See also Installation guidelines on page 189.

RATINGS	IP: 55	UL/NEMA: 3, 12, 12K
---------	--------	---------------------

CN DE ES FR EN	套件	所能密封电缆/管道的直径范围和数量			重量 (千克) (磅)		货号
	Kit	Durchmesserbereich und Anzahl der Kabel/Rohre			Gewicht (kg) (lb)		Art.-Nr.
	Kit	Intervalo de diámetros y número de cables/tuberías			Peso (kg) (libra)		Nº art.
	Kit	Plage des diamètres et nombre de traversants possibles			Poids (kg) (lb)		Nº d'article
	Kit	Diameter range and number of cables/pipes			Weight (kg) (lb)		Art No.
		0+3.5-16.5 mm 0+0.138-0.650 in (CM 20W40)	0+9.5-32.5 mm 0+0.374-1.280 in (CM 40 10-32)	0+28-43 mm 0+1.102-1.693 in (CM 50)			
	ComSeal™ 10/4	2 cables/pipes	2 cables/pipes		0.515	1.13	105299
	ComSeal™ 10/7	6 cables/pipes	1 cable/pipe		0.515	1.13	105301
	ComSeal™ 10/10	10 cables/pipes			0.515	1.13	105302
	ComSeal™ 12/3		3 cables/pipes		0.61	1.34	105303
	ComSeal™ 12/6	4 cables/pipes	2 cables/pipes		0.61	1.34	105305
	ComSeal™ 12/9	8 cables/pipes	1 cable/pipe		0.61	1.34	105306
	ComSeal™ 12/12	12 cables/pipes			0.61	1.34	105307
	ComSeal™ 15/3			3 cables/pipes	0.91	2.0	105308
	ComSeal™ 16/4		4 cables/pipes		0.666	1.47	105310
	ComSeal™ 16/7	4 cables/pipes	3 cables/pipes		0.666	1.47	105312
	ComSeal™ 16/10	8 cables/pipes	2 cables/pipes		0.666	1.47	105313
	ComSeal™ 16/16	16 cables/pipes			0.666	1.47	105314
	ComSeal™ 30/6			6 cables/pipes	1.40	3.09	105315
	ComSeal™ 32/8		8 cables/pipes		1.259	2.78	105316
	ComSeal™ 32/14	8 cables/pipes	6 cables/pipes		1.259	2.78	105320
	ComSeal™ 32/20	16 cables/pipes	4 cables/pipes		1.259	2.78	105321
	ComSeal™ 32/32	32 cables/pipes			1.259	2.78	105322

ComSeal™ frame, technical information

ComSeal™ 框架, 技术信息 | ComSeal™ Rahmen, technische Daten | Marcos ComSeal™, información técnica | Cadres ComSeal™, informations techniques

RECTANGULAR FRAMES

ComSeal™ 10

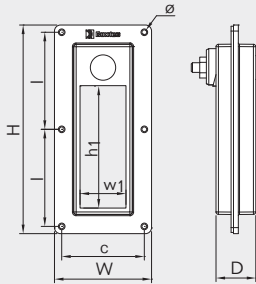

ComSeal™ 12

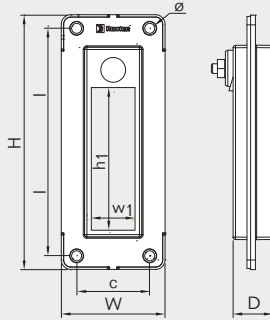

ComSeal™ 15

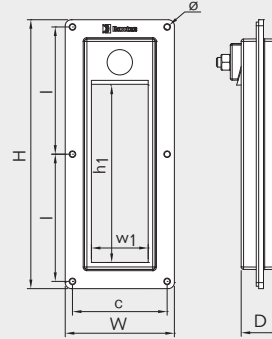

ComSeal™ 16

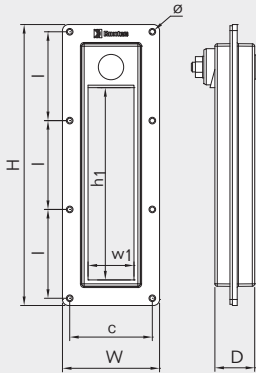

ComSeal™ 30

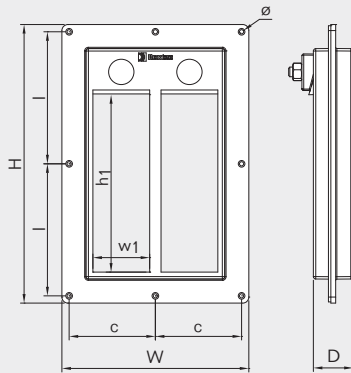

ComSeal™ 32

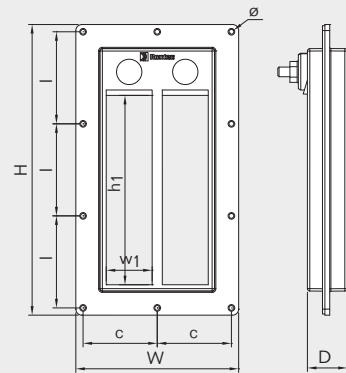

Pos	ComSeal™ 10		ComSeal™ 12		ComSeal™ 15		ComSeal™ 16		ComSeal™ 30		ComSeal™ 32	
	(mm)	(in)	(mm)	(in)	(mm)	(in)	(mm)	(in)	(mm)	(in)	(mm)	(in)
c	68.5	2.697	62	2.441	78.5	3.091	68.5	2.697	71.5	2.815	61.5	2.421
D	33	1.299	33	1.299	33	1.299	33	1.299	33	1.299	33	1.299
H	173	6.811	216	8.504	223	8.780	233	9.173	231	9.094	241	9.488
h ₁	100	3.937	120	4.724	150	5.906	160	6.299	150	5.906	160	6.299
l	80.5	3.169	193	7.598	105.5	4.154	73.7	2.902	109.5	4.311	76.33	3.005
w ₁	40	1.575	40	1.575	50	1.969	40	1.575	50	1.969	40	1.575
W	80.5	3.169	88	3.465	90.5	3.563	80.5	3.169	155	6.102	135	5.315
∅	5.5	0.217	8.5	0.335	5.5	0.217	5.5	0.217	5.5	0.217	5.5	0.217

Note: All dimensions are nominal values

注意: 所有的尺寸都是参考值

Achtung: Alle angegebenen Maße sind Nominalwerte

Nota: Todas las dimensiones son valores nominales

N.B.: toutes les dimensions sont nominales

Roxtec ComSeal™ 12 fits the FL 21 knock-out

Roxtec ComSeal™ 12适合FL 21开孔

Roxtec ComSeal™ 12 ist passend für den FL 21-Ausschnitt

Roxtec ComSeal™ 12 sirve con corte FL 21

Roxtec ComSeal™ 12 correspond à la barrière désactivante FL 21

ComSeal™ 10, 12, frames, holecut

ComSeal™ 10, 12 框架, 安装指导
 ComSeal™ 10, 12 Rahmen, Lochausschnitt
 ComSeal™ 10, 12 Marco, corte del hueco
 Cadres ComSeal™ 10, 12 taille de la découpe

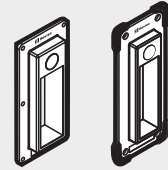

ComSeal™ 10

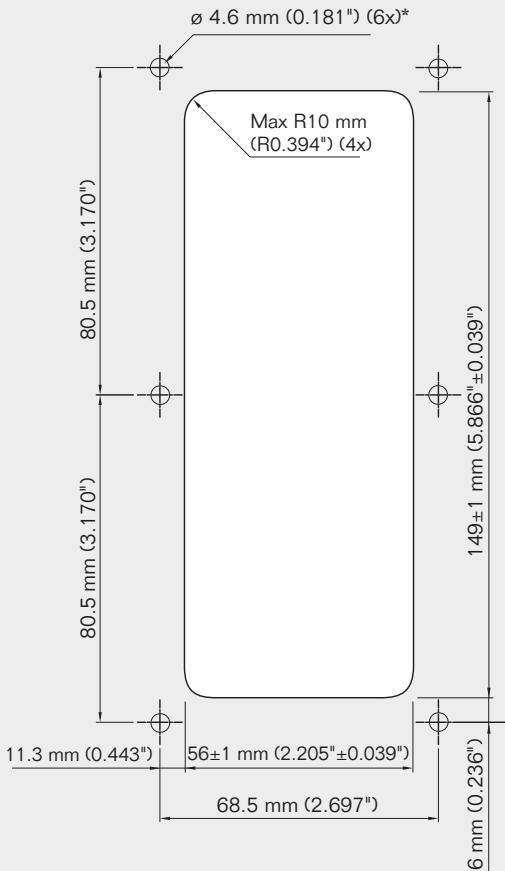

ComSeal™ 12

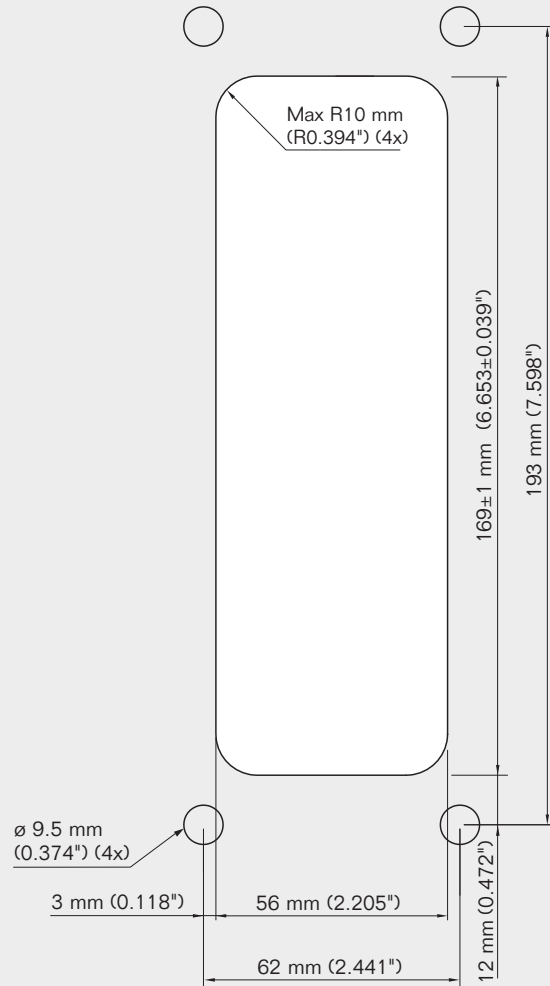

Roxtec ComSeal™ LW 12 fits FL 21 knock-out (holecut).

* $\varnothing 5.5 (7/32")$. Drill bit size when using nuts.

Not scale 1:1

ComSeal™ 15, 16 frames, holecut

ComSeal™ 15, 16 框架, 安装指导
 ComSeal™ 15, 16 Rahmen, Lochausschnitt
 ComSeal™ 15, 16 Marco, corte del hueco
 Cadres ComSeal™ 15, 16, taille de la découpe

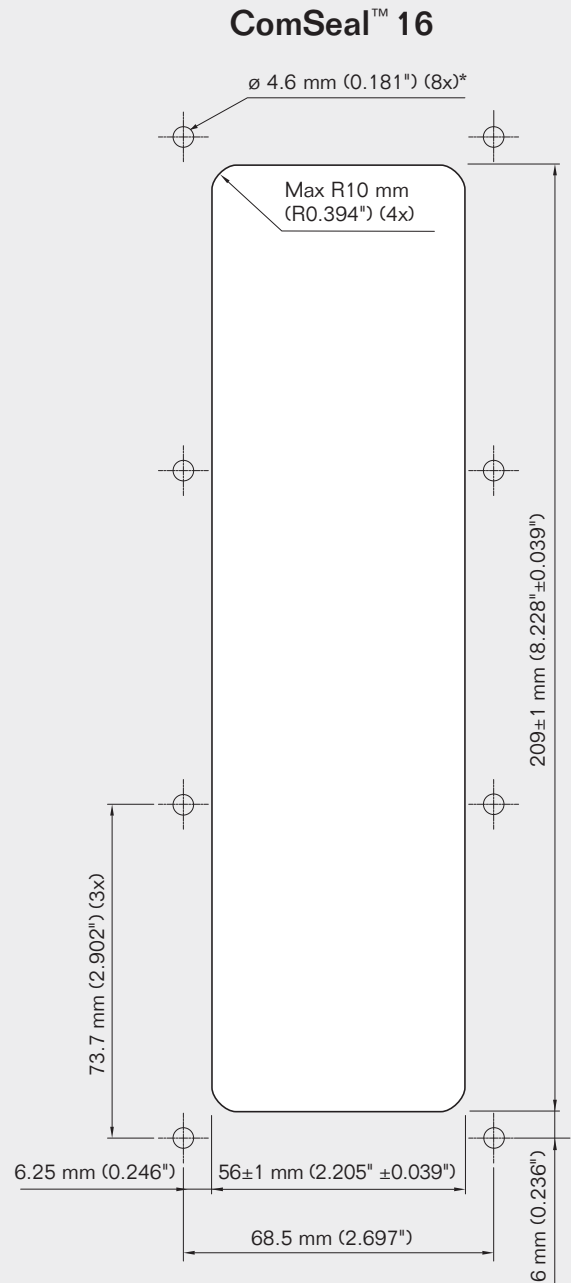
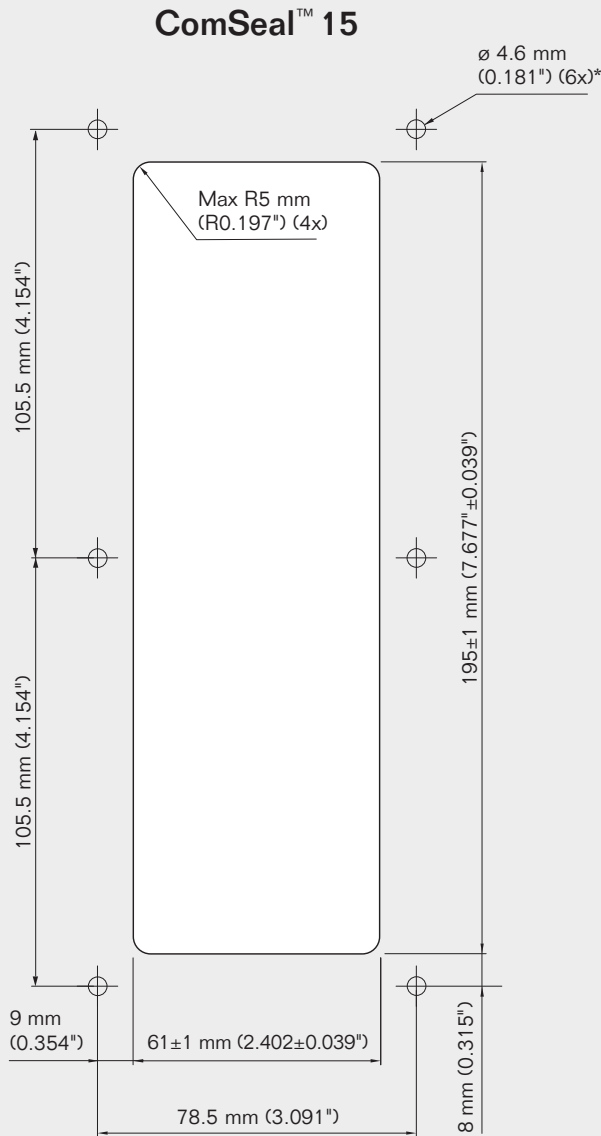
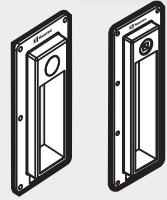

* \varnothing 5.5 (7/32"). Drill bit size when using nuts.

Not scale 1:1

ComSeal™ 30, 32 frame, holecut

ComSeal™ 30, 32 框架, 安装指导
 ComSeal™ 30, 32 Rahmen, Lochausschnitt
 ComSeal™ 30, 32 Marco, corte del hueco
 Cadres ComSeal™ 30, 32, taille de la découpe

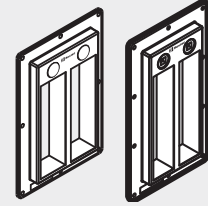

ComSeal™ 30

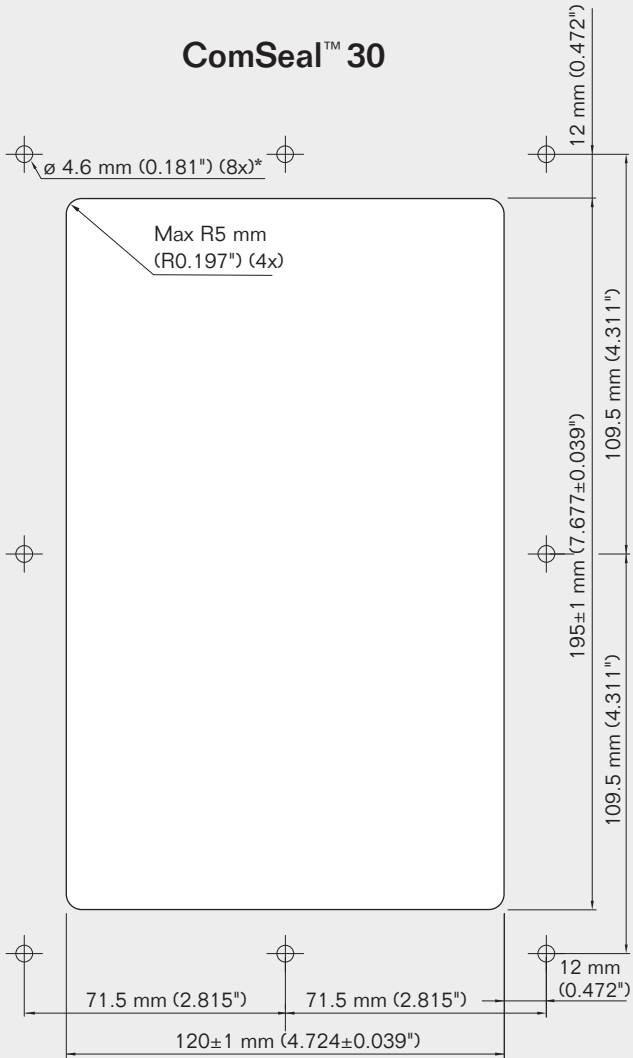

ComSeal™ 32

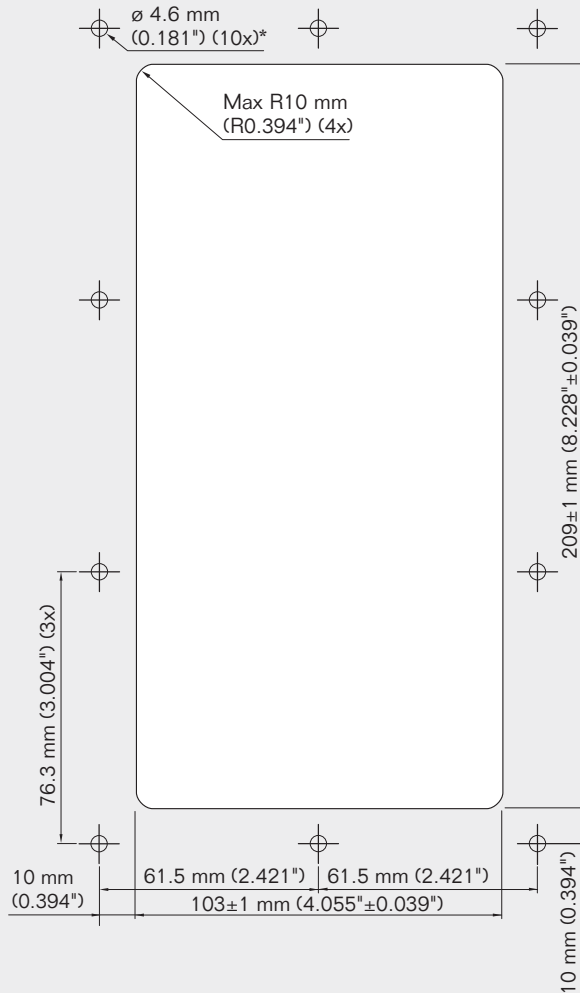

* $\varnothing 5.5$ (7/32"). Drill bit size when using nuts.

Not scale 1:1