

UNIVERSAL
new **UNIBOX**
SERIES
ALUMINIUM JUNCTION BOXES





Product characteristics

Norms of conformity: CEI EN 60670-1 CEI EN 60529 CEI EN 50102
 Material: EN 1076 AC-46100DF (ex UNI 5076) light aluminium alloy
 Protection rating: IP66 / IP67
 Impact resistance: IK08
 Temperature resistance: from -40°C up to +100°C (up to +150°C for short periods)
 Insulation class: Class I
 Surface treatment: Passivation with anti-corrosion fluor-zirconium treatment
 Painting: Hot polymerized non-toxic polyester
 Colour: RAL 7042 light hammer finish
 Irradiation: High UV resistance

Covers complete with captive screws in stainless steel.
 DIN rail can be fixed horizontally or vertically
 by using M4x6 self-tapping screws.
 DIN rail can be fixed diagonally on supports.



520011



522011



521011

The range

Description	Dimensions (mm)		Enclosures		Back Plates		Profiles	
	External	Internal	Code	No. Pcs. Package	Code	No. Pcs. Package	Code	No. Pcs. Package
Enclosure UNI B9	100x100x59	88x88x44	520009	12	-----	---	521009	1
Enclosure UNI B11	140x115x60	128x103x46	520011	12	522011	1	521011	1
Enclosure UNI B12	166x141x64	153x128x49	520012	6	522012	1	521012	1
Enclosure UNI B14	192x168x80	176x152x65	520014	6	522014	1	521014	1
Enclosure UNI B19	253x217x93	236x201x75	520019	1	522019	1	521019	1
Enclosure UNI B20	314x264x122	292x243x104	520020	1	522020	1	521020	1
Enclosure UNI B21	410x315x150	386x291x126	520021	1	522021	1	521021	1

The advantages



Easy to be installed

Can be fixed by keeping the screwdriver perpendicular to the screw.

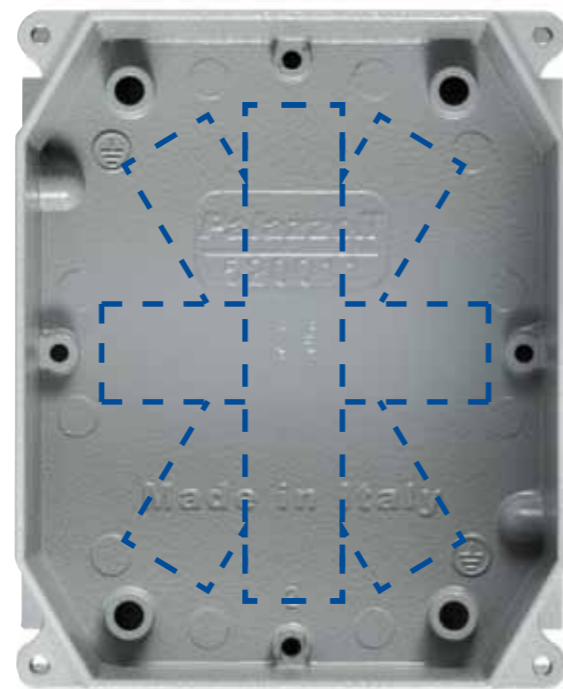

Complete set of supports

DIN rail can be fixed in any position without using accessories.



IP66/IP67





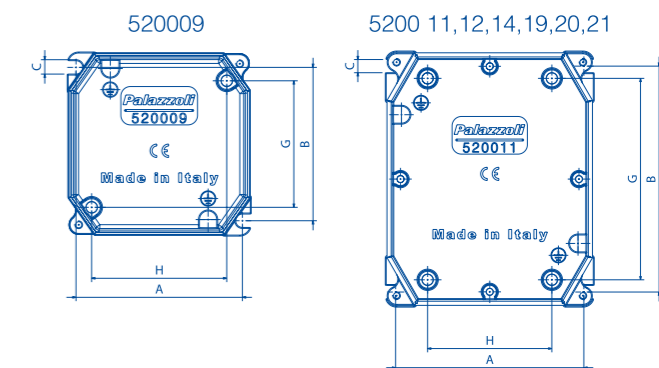

Earth connection can be made externally, without losing IP66/IP67 protection rating.

Dimensions and fixing patterns

	A	B	C	G	H
520009	86	80	7	66	70,5
520011	120	100	7	107	66
520012	125	144	7,5	121	99
520014	149	168	7,5	153	113
520019	196	226	10	188	153
520020	236	275	10	238	198
520021	283	367	10	333	248



The widest range of enclosures for any kind of application

<p>Tertiary</p> <p>Pubs, offices, fairs, photo studios.</p>	<p>Ph – Thermoplastic</p> 
<p>Industry</p> <p>Textile, moulding, technical rooms, dairies.</p>	<p>Tais – Thermosetting (GRP)</p> 
<p>Services Automation Industry</p> <p>Machineries, parks, outlets, garages, electronic applications (RFI shielding).</p>	<p>Unibox – Aluminium alloy</p> 
<p>Heavy industry</p> <p>Metallurgic and steel industries, petrochemical, chemical.</p>	<p>Alupres – Die cast aluminium</p> 
<p>Ships/Marine</p>	<p>Marine – Brass</p> 
<p>Fire proof</p> <p>Road and railway tunnels.</p>	<p>Tunnel54 - Fire proof aluminium</p> 
<p>Explosion proof</p> <p>Gas or dust potentially explosive atmospheres.</p>	<p>Atex – Explosion proof</p> 