

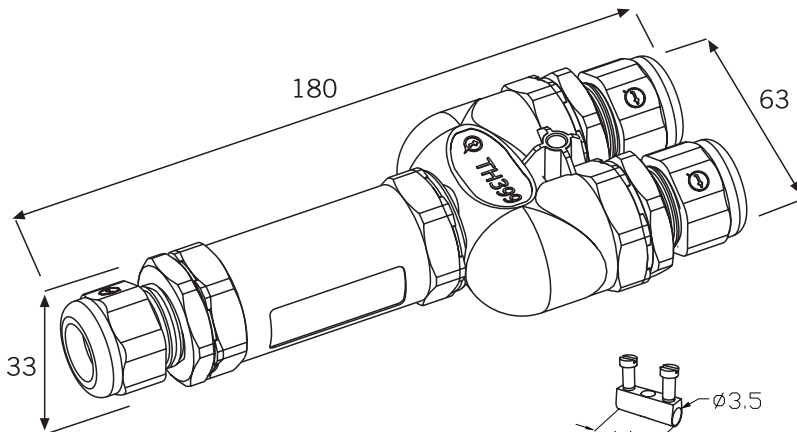

TH399

PATENTED IP68

2-3-5-6
3+3
Poli



Capacita' di connessione fino a 6°
Connection capability up to 6°

Morsetiera lineare a 3 vie. Uscita a "Y" elevato grado IP.

Protected connection solution of the linear type with "Y" exit and high IP rate.

Dati tecnici - Technical data

250 V~	4 °	IP68
PTI 250	T85° C	2 BAR

Tipo di cavo utilizzabile in funzione della temperatura ambiente			
Temperatura ambiente Ambient temperature	Tipo di cavo utilizzabile Suitable cable	Sezione minima Smallest cross-sectional	Sezione massima Largest cross-sectional
T85	H05SS-F	3G1,5mm ² 5G1,5mm ²	3G 4mm ² 5G2,5mm ²

Coppia torsione Torque force	Tube-Corpo pressacavo Tube-Cable gland body	Corpo pressacavo-Dado Cable gland body-Nut
2-3-5-6 3+3 P	2.5 Nm \otimes 29	2.5 Nm \otimes 24 4 Nm \otimes 29

Materie prime - Raw materials

Materia plastica - Plastics

PA66 UL94 V2 GWT 850°C
PA66GF UL94 V0 GWT 960°C

■ Nero - Black

-20°C
+125°C

Gomme - Rubbers

Gommini- *sealing inserts*: TPE-V - NBR
Guarnizioni - *seals*: SILICONE *silicon*

Bussole- Insert

M3 Acciaio zincato passivato
Zinc plated steel

Ottone nichelato Nickel plated brass		A
Bussola cieca End barrier insert		B
Bussola STD STD insert Bussola WP WP insert		C

Norme - Standards

EN60529:1991+A1:2000-
IP68:20MT-PROF;60 MIN
EN 60998-1:2004
EN 60998-2-1:2004



Codice - Part number

T H B . 3 9 9 . X X X

LUNGO LONG Min-Max Ø cavo - cable $\oplus \ominus$ Ø 5÷17 mm

2 poli-2 poles

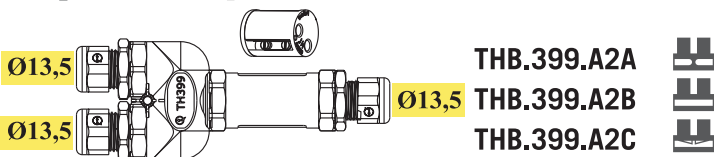

3 poli-3 poles

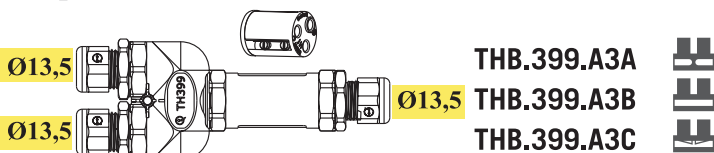

5 poli-5 poles

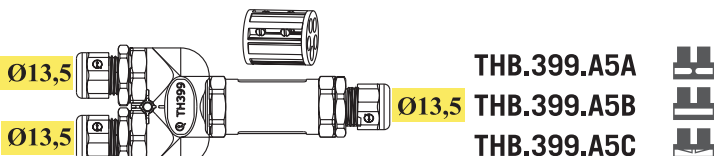

6 poli-6 poles

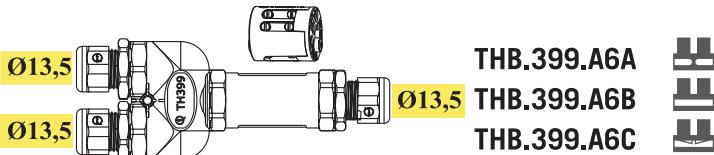

2+2 poli-2+2 poles 3+3 poli-3+3 poles

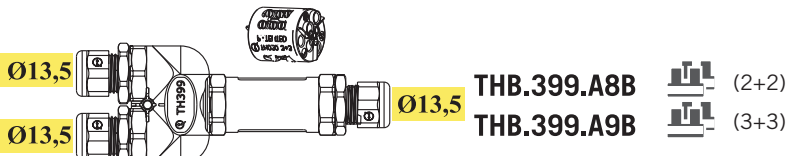

Eventuali modifiche e migliorie sui dati tecnici o sul prodotto potranno essere effettuate senza preavviso.
All technical data or other eventual product modifications and improvements can be carried out without notice

2 poli-2 poles

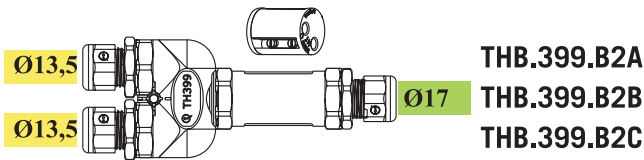

3 poli-3 poles

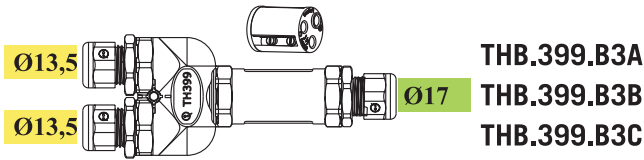

5 poli-5 poles

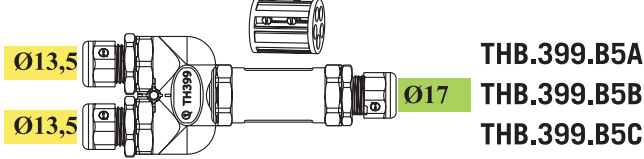

6 poli-6 poles

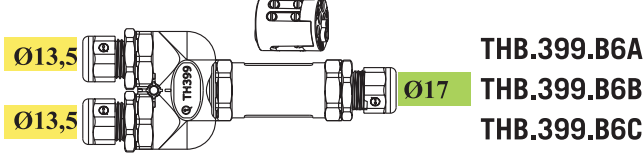

2+2 poli-2+2 poles 3+3 poli-3+3 poles

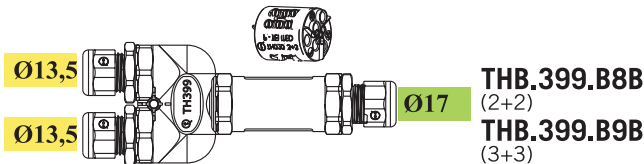

2 poli-2 poles

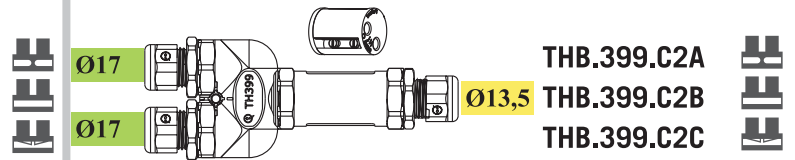

3 poli-3 poles

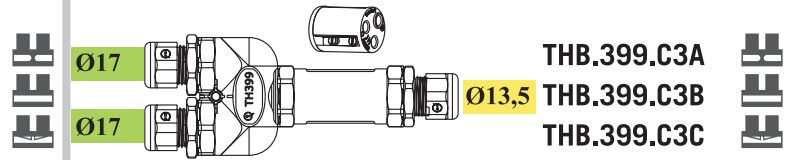

5 poli-5 poles

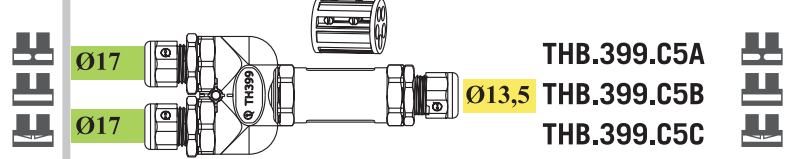

6 poli-6 poles

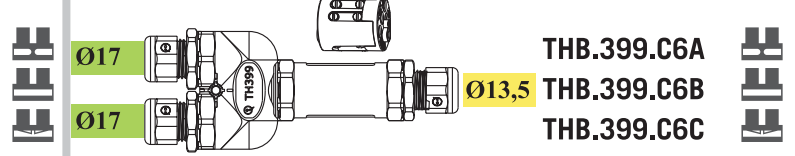

2+2 poli-2+2 poles 3+3 poli-3+3 poles

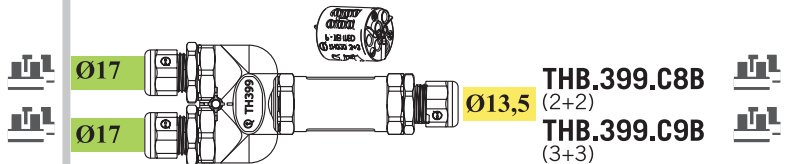

2 poli-2 poles

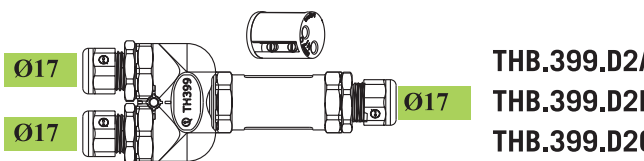

3 poli-3 poles

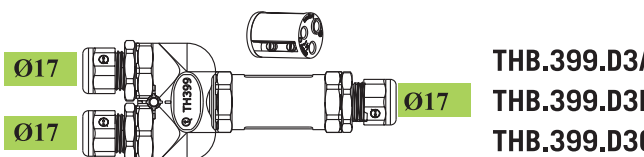

5 poli-5 poles

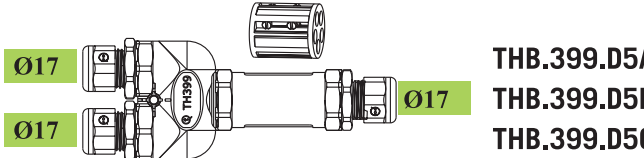

6 poli-6 poles

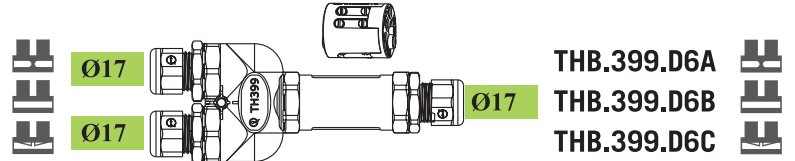

2+2 poli-2+2 poles 3+3 poli-3+3 poles

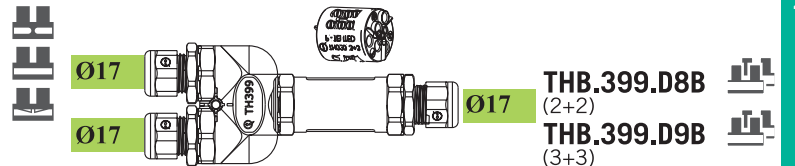

Kit di fornitura non assemblato THB Unassembled kit THB

THB.399.XXX
*VERSIONE A LUNGA
LONG VERSION*

Min-Max Ø cavo - cable Ⓟ Ⓢ Ø 8÷17 mm

Box: C07, 100 PZ, mm240 height, mm390 width, mm590 length.

100 PZ (cable), 100 PZ (tube), 300 PZ (nut), 400 PZ (washer), 100 PZ (terminal).

THB.399.EXX
*VERSIONE CORTA
SMALL VERSION*

Min-Max Ø cavo - cable Ⓟ Ⓢ Ø 5÷13,5 mm

Box: C07, 200 PZ, mm240 height, mm390 width, mm590 length.

200 PZ (cable), 200 PZ (tube), 600 PZ (nut), 800 PZ (washer), 200 PZ (terminal).

Kit di fornitura assemblato THZ Assembled kit THZ

THZ.399.XXX

Box: C05, 50 PZ, mm185 height, mm395 width, mm395 length.

50 PZ (assembled unit)

THZ.399.EXX

Box: C05, 100 PZ, mm185 height, mm395 width, mm395 length.

100 PZ (assembled unit)

Kit di fornitura imbustati THR Fare riferimento a catalogo THR Retail packed kit THR Please refer to THR Retail Catalogue

THR.399.SXX

Box: C07, 25 CONF, mm240 height, mm390 width, mm590 length.

Box: C05, 25 CONF, mm185 height, mm395 width, mm395 length.

1 CONF (bagged kit), 1 PZ (bagged kit)

Kit di fornitura con versionamenti e confezionamenti speciali THK Special custom packed version THK

THK.399.XXX

Box: PZ, mm height, mm width, mm length.

Vedi istruzioni di assemblaggio
Refer to user instructions



TH399

PATENTED IP68

2-3
Poli

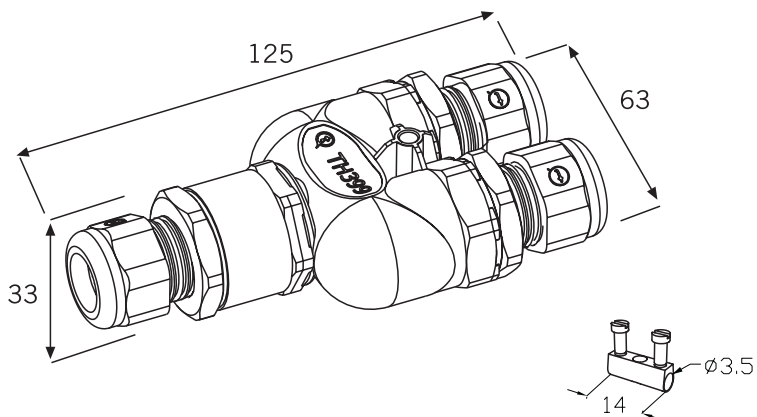

Capacità di connessione fino a 6°
Connection capability up to 6°

Morsettiera lineare a 3 vie. Uscita a "Y" elevato grado IP.

Protected connection solution of the linear type with "Y" exit and high IP rate.

Dati tecnici - Technical data

250 V~	4 °	IP68
PTI 250	T85° C	2 BAR

Tipo di cavo utilizzabile in funzione della temperatura ambiente			
Temperatura ambiente Ambient temperature	Tipo di cavo utilizzabile Suitable cable	Sezione minima Smallest cross-sectional	Sezione massima Largest cross-sectional
T85	H05SS-F	3G1,5mm ² 5G1,5mm ²	3G 4mm ² 5G2,5mm ²

Coppia torsione Torque force	Tube-Corpo pressacavo Tube-Cable gland body	Corpo pressacavo-Dado Cable gland body-Nut
2-3 P	2.5 Nm 29	2.5 Nm 24

Materie prime - Raw materials

Materia plastica - Plastics

PA66 UL94 V2 GWT 850°C
PA66GF UL94 V0 GWT 960°C

■ Nero - Black

-20°C

+125°C

Gomme - Rubbers

Gommini- *sealing inserts*: TPE-V
Guarnizioni - *seals*: SILICONE *silicon*

Bussole- Insert

M3 Acciaio zincato passivato
Zinc plated steel

Ottone nichelato Nickel plated brass	Bussola cieca End barrier insert		1
	Bussola STD STD insert		2
	Bussola WP WP insert		3

Norme - Standards

EN60529:1991+A1:2000-
IP68:20MT-PROF;60 MIN
EN 60998-1:2004
EN 60998-2-1:2004



Codice - Part number

T H B . 3 9 9 . X X X

CORTO
SHORT

Min-Max Ø cavo - cable Ø 5÷13,5 mm

3 VIE - 3 WAYS

2 poli-2 poles

Ø 13,5		Ø 13,5		THB.399.E2A	
Ø 13,5		Ø 13,5		THB.399.E2B	
				THB.399.E2C	

3 poli-3 poles

Ø 13,5		Ø 13,5		THB.399.E3A	
Ø 13,5		Ø 13,5		THB.399.E3B	
				THB.399.E3C	

Kit di fornitura non assemblato THB Unassembled kit THB

THB.399.XXX
*VERSIONE A LUNGA
LONG VERSION*

Min-Max Ø cavo - cable Ⓟ Ⓢ Ø 8÷17 mm

Box: C07, mm390 x mm590 x mm240, 100 PZ
Terminal: 100 PZ
Tube: 100 PZ
Nut: 300 PZ
Washer: 400 PZ
Assembly: 100 PZ

THB.399.EXX
*VERSIONE CORTA
SMALL VERSION*

Min-Max Ø cavo - cable Ⓟ Ⓢ Ø 5÷13,5 mm

Box: C07, mm390 x mm590 x mm240, 200 PZ
Terminal: 200 PZ
Tube: 200 PZ
Nut: 600 PZ
Washer: 800 PZ
Assembly: 200 PZ

Kit di fornitura assemblato THZ Assembled kit THZ

THZ.399.XXX

Box: C05, mm395 x mm395 x mm185, 50 PZ
Assembly: 50 PZ

THZ.399.EXX

Box: C05, mm395 x mm395 x mm185, 100 PZ
Assembly: 100 PZ

Kit di fornitura imbustati THR Fare riferimento a catalogo THR Retail packed kit THR Please refer to THR Retail Catalogue

THR.399.SXX

Box: C07, mm390 x mm590 x mm240, 25 CONF
Box: C05, mm395 x mm395 x mm185, 25 CONF
Assembly: 1 CONF, 1 PZ

Kit di fornitura con versionamenti e confezionamenti speciali THK Special custom packed version THK

THK.399.XXX

Box: PZ, mm x mm x mm

Vedi istruzioni di assemblaggio
Refer to user instructions